

Instruction Manual

Residential Swing Gate Operator

RAM 30

Opening the way...



FOR CLASS I VEHICULAR GATE OPERATORS

TABLE OF CONTENTS

Important Safety Requirements & Instructions 1

Responsibilities of Installers and Technicians 2

Important Safety Requirements by UL Standards 3

Classes of Vehicular Gate Operators/Recommended Electrical Connection 4

General Specifications 5

Installation Specifications 6

Hookup Electrical Power - Gate Travel Adjustment 7

Standard Installation in Closed and Opened Position 8

Compact Installation in Closed and Opened Position 9

Sensor Installation 10

Pushbutton Controls & Master/Slave Installation 11

Dip Switch Configuration 12-13

Terminal Strip Connections for Optional Accessories 14-15

Ramset "Intelligence" Control Board 16

Wire Board Connections 17

Exploded View 18

Bill of Materials 19-20

Troubleshooting Table 21

Gate Entrance Safety Precautions 22

Important Information for The Homeowner..... 23

Optional Ramset Accessories 24

 **Do not install this gate operator if you do not have experience or appropriate training with gate operators.**

WARNING:

 **IMPORTANT SAFETY REQUIREMENTS & INSTRUCTIONS**

WARNING To reduce the risk of injury or death:

<ol style="list-style-type: none"> 1. READ AND FOLLOW ALL INSTRUCTIONS. 2. Never let children operate or play with gate controls. Keep the remote control away from children. 3. Always keep people and objects away from the gate. NO ONE SHOULD CROSS THE PATH OF THE MOVING GATE. 4. Test the Vehicular Gate Operator monthly. The gate MUST reverse on contact with a rigid object or stop when an object activates the non-contact sensors. After adjusting the limit of travel, retest the Vehicular Gate Operator. Failure to adjust and retest the 	<p>Vehicular Gate Operator properly can increase the risk of injury or death.</p> <ol style="list-style-type: none"> 5. Use the Emergency Release <u>only when power switch or circuit breaker has been turned off</u>. Using the Emergency Release during a power failure can be a hazard if power is abruptly restored. 6. KEEP GATES PROPERLY MAINTAINED. Read the Owner's Manual. Have a qualified service person make repairs to gate hardware. 7. The entrance is for vehicles only. Pedestrians must use separate entrance. 8. SAVE THESE INSTRUCTIONS.
------------------------------------------------------------------------------------------------------------------------------------------------------------------------------------------------------------------------------------------------------------------------------------------------------------------------------------------------------------------------------------------------------------------------------------------------------------------------------------------------------------------------------------------------------------------------------------------------------	----------------------------------------------------------------------------------------------------------------------------------------------------------------------------------------------------------------------------------------------------------------------------------------------------------------------------------------------------------------------------------------------------------------------------------------------------------------------------------------------------------------------------------------------------------------------------------------------------------

RESPONSIBILITIES OF INSTALLERS AND TECHNICIANS

INSTALLATION:

- READ AND UNDERSTAND THE INSTRUCTION MANUAL BEFORE ATTEMPTING ANY INSTALLATION.
- DO NOT EXCEED THE EQUIPMENT SPECIFICATIONS.
- INSURE A SAFE AND PROPER INSTALLATION.
- INSTALL THIS EQUIPMENT IN ACCORDANCE WITH THE UL 325 SPECIFICATIONS.
- MAKE SURE TO ELIMINATE ANY PINCH POINTS EXISTING ON THE INSTALLATION.
(ie. ROLLERS, ARMS...etc.)

SAFETY DEVICES:

- REMOVE OR PROTECT ALL PINCH POINTS FROM GATE OPERATORS ARMS.
- MAKE SURE EVERY INSTALLATION HAS A MINIMUM OF ONE SAFETY DEVICE (SUCH AS A PHOTOELECTRIC EYE OR LOOP DETECTOR).
- CHECK THE E.R.D. SENSITIVITY.
- MAKE SURE THAT ALL AREAS AROUND THE GATE ARE SAFE AND SECURE. (SUCH AS THE FRONT, REAR, AND TRAVEL AREA).

COMMUNICATE WITH THE END-USER

- INSTRUCT THE END USER ON HOW TO SAFELY OPERATE ALL FUNCTIONS OF THE OPERATOR.
- INSTRUCT THE END-USER ON HOW TO SAFELY USE THE EMERGENCY RELEASE.
- CLEARLY LABEL AND IDENTIFY THE CIRCUIT BREAKER FOR THE OPERATOR.
- SHOW THE END-USER THE LOCATION OF THE CIRCUIT BREAKER FOR THE OPERATOR.
- THOROUGHLY EXPLAIN ANY AND ALL WARRANTIES ASSOCIATED WITH THE OPERATOR AND INSTALLATION.
- KEEP A COPY OF EACH MANUAL HANDY FOR FUTURE REFERENCES.
- PROVIDE THE END-USER WITH THE "HOME OWNERS MANUAL PACKET" (INCLUDED WITH EVERY OPERATOR).

IMPORTANT SAFETY REQUIREMENTS BY UL STANDARDS

Prior to installation of a Ramset gate operator, the following must be observed: (per UL 325.51.8.4).

- a)** Install the vehicular gate operator only when:
- 1) The Vehicular Gate Operator is appropriate for the construction of the gate and the usage class of the gate.
 - 2) All openings of a horizontal slide gate are guarded or screened from the bottom of the gate to a minimum of 4 feet (1.2 m.) above the ground to prevent a 2 1/4 inch (57.15 mm.) diameter sphere from passing through the openings anywhere in the gate, and in that portion of the adjacent fence that the gate covers in the open position.
 - 3) All exposed pinch points are eliminated or guarded.
 - 4) Guarding is supplied for exposed rollers.
- b)** The Vehicular Gate Operator is intended for installation only on gates used for vehicles. Pedestrians must be supplied a separate access opening.
- c)** The gate must be installed in a location so that enough clearance is supplied between the gate and adjacent structures when opening and closing to reduce the risk of entrapment. Swinging gates shall not open into public access areas.
- d)** The gate must be properly installed and work freely in both directions prior to the installation of the Vehicular Gate Operator. Do not over-tighten the operator clutch to compensate for a damaged gate.
- e)** Controls must be far enough from the gate so that the user is prevented from coming in contact with the gate while operating the controls. Controls intended to be used to reset a Vehicular Gate Operator after 2 sequential activations of the entrapment protection device or devices must be located in the line-of-sight of the gate. Outdoor or easily accessible controls shall have a security feature to prevent unauthorized use.
- f)** All warning signs and placards must be installed where visible in the area of the gate.
- g)** For Vehicular Gate Operators utilizing a non-contact sensor in accordance with 30A.1.1 Type B1 non-contact sensor (photo electric sensor or the equivalent).
- 1) See instructions on the placement of non-contact sensors for each type of application.
 - 2) Care shall be exercised to reduce the risk of nuisance tripping, such as when a vehicle, trips the sensor while the gate is still moving, and.
 - 3) One or more non-contact sensors shall be located where the risk of entrapment or obstruction exists, such as the perimeter reachable by a moving gate or barrier.
- h)** For a Vehicular Gate Operator utilizing a contact sensor in accordance with 30A.1.1
- 1) One or more contact sensors shall be located at the leading edge, trailing edge, and post-mounted both inside and outside of a vehicular horizontal slide gate.
 - 2) One or more contact sensors shall be located at the bottom edge of a vehicular vertical lift gate.
 - 3) One or more contact sensors shall be located at the pinch point of a vehicular vertical pivot gate.
 - 4) A hardwired contact sensor shall be located and its wiring arranged so that the communication between the sensor and the vehicular gate operator is not subjected to mechanical damage.
 - 5) A wireless contact sensor such as one that transmits radio frequency (RF) signals to the vehicular gate operator for entrapment protection functions shall be located where the transmission of the signals are not obstructed or impeded by building structures, natural landscaping or similar obstruction. A wireless contact sensor shall function under the intended end-use conditions.

CLASSES OF VEHICULAR GATE OPERATORS

Vehicular horizontal slide-gate operator (or system) - A vehicular gate operator (or system) that controls a gate which slides in a horizontal direction that is intended for use for vehicular entrance or exit to a drive, parking lot, or the like.

Vehicular swing-gate operator (or system) - A vehicular gate operator (or system) that controls a gate which swings in an arc in a horizontal plane that is intended for use for vehicular entrance or exit to a drive, parking lot or the like.

Residential vehicular gate operator-Class I - A vehicular gate operator (or system) intended for use at a home of one-to four single family dwellings, or a garage or parking area associated there with.

Commercial/general access vehicular gate operator-Class II - A vehicular gate operator (or system) intended for use in a commercial location or building such as a multi-family housing unit (five or more single family units), hotels, garages, retail stores, or other buildings serving the general public.

Industrial/limited access vehicular gate operator-Class III - A vehicular gate operator (or system) intended for use in an industrial location or building such as a factory or loading dock area or other locations not intended to service the general public.

Restricted access vehicular gate operator-Class IV - A vehicular gate operator (or system) intended for use in a guarded industrial location or building such as an airport security area or other restricted access locations not servicing the general public, in which unauthorized access is prevented via supervision by security personnel.

RECOMMENDED ELECTRICAL CONNECTION

For a single operator use a 3 wire, 120 VAC or 220 VAC electrical circuit with a 15 amp independent circuit breaker. Loop wires and low voltage wires, should use separated conduit!

NOTE: Always consult and follow all local building and electrical codes prior to installation!

RECOMMENDED WIRE GAUGE

		AMPERE	
INPUT POWER	MOTOR HP	RUN	START
120V Single Phase	1/2	4.7	5.0

MAXIMUM CONDUIT DISTANCE IN FEET USING COPPER WIRE BY WIRE SIZE			
14ga.	12ga.	10ga.	8ga.
up to 100'	100-350'	350-650'	800'

RAM 30

GENERAL SPECIFICATIONS:

Maximum Gate Size & Weight: 12' @ 400 lbs.
Gate Traveling Speed: Approx. 90° opening in 16 sec.
Cycles: 30 per hour. / Shipping: 75 lbs.
Application: Residential.

WARNING: Do not exceed the specifications.

IMPORTANT:
Always shut power Off before attempting to use the emergency release.

POWER FAILURE RELEASE:.



1. Remove knob from top cap



2. Loose knob from clamp arm.



3. Slightly bend the arms at the elbow and secure the gate from free-movement to relieve the pressure on the operator from the gate.



4. Carefully lift off the clamp release and arm.

5. Push gate open.



Heavy Duty Torque-limiter:

Absorbs high impacts on gates to minimize damage on gear reducer.



Heavy Duty Worm Gear:

Lubricated by oil bath gives smooth and quiet operation.



Electric Motor:

1/2 hp 120 VAC 5.2 amp 1625 rpm 50/60Hz continuous duty with high speed ball bearings and resettable overload button.



Capacitor:

Aerovox 65µf 240V 50/60Hz protected S 1000AFC.



Heavy Duty Pillow Block Assembly:

High speed sealed ball bearings.



Limit Switches:

For accurate gate stop settings.



Ramset "Intelligate" Control Board

It is controlled by a programmable microprocessor that reads and precisely executes all functions.

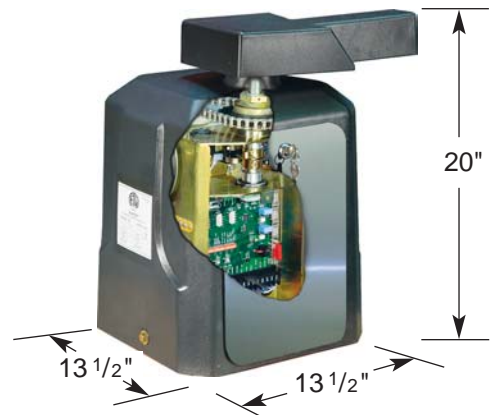

Chassis: 3/16" Hot rolled metal. Cold/zinc plated to inhibit corrosion.

Cover: High-impact resistant charcoal grey polyethylene.

INSTALLATION SPECIFICATIONS

CONCRETE PAD CONSTRUCTION:

Dimensions given for the pad are based on soil bearing shear of 2000 P.S.F. These figures may have to be adjusted depending on local soil conditions.

1. Construct form for mounting pad according to dimensions shown in Figure 1 and 2.
2. Locate mounting pad according to dimensions given in illustration.
3. Level top edge of form.
4. Set reinforcing bars and wire mesh.
5. Allow pad to cure for 48 hours, and remove forms.
6. Note: conduits 6" above concrete pad.

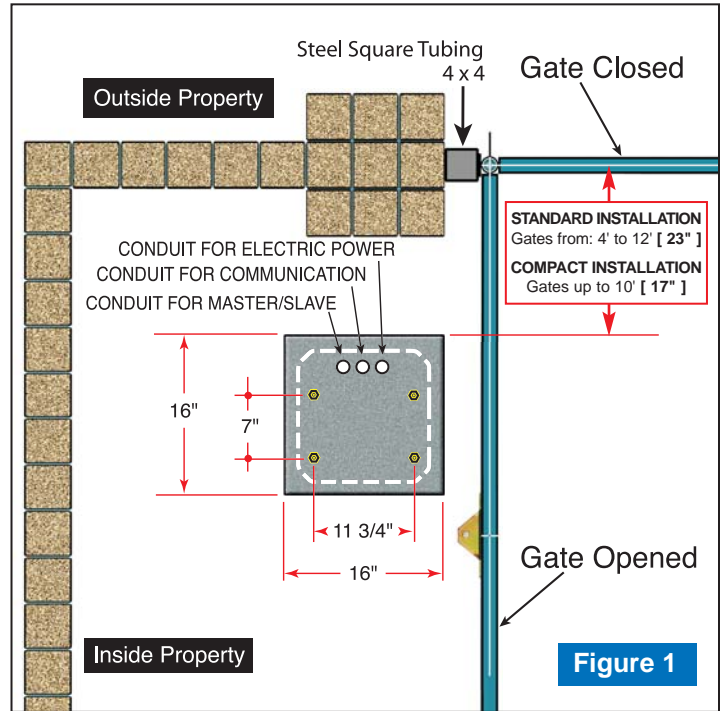
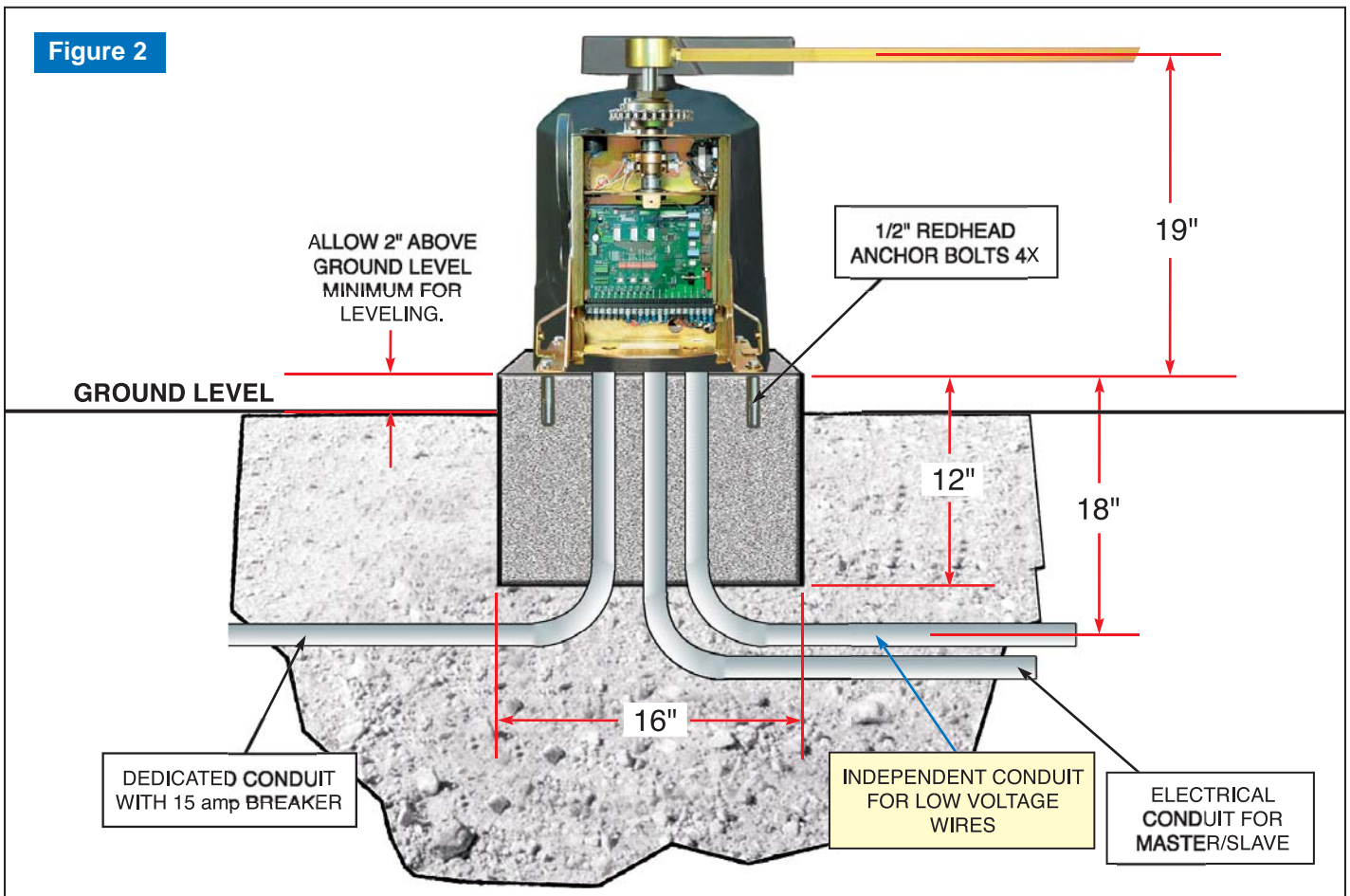
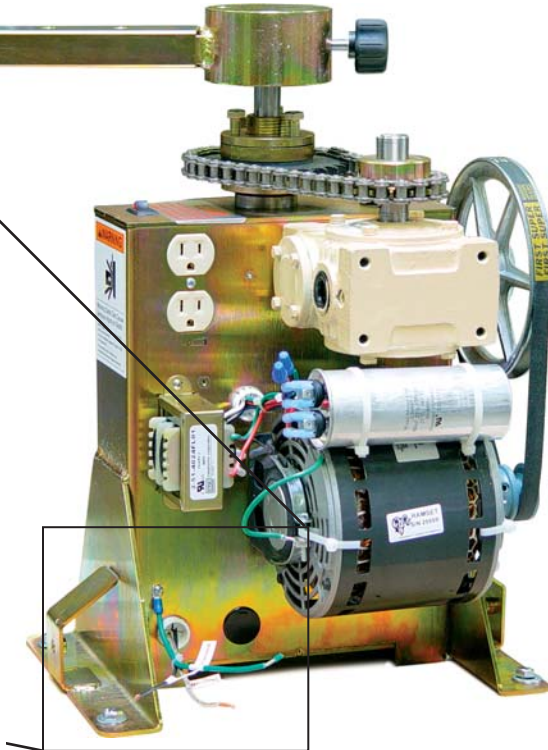
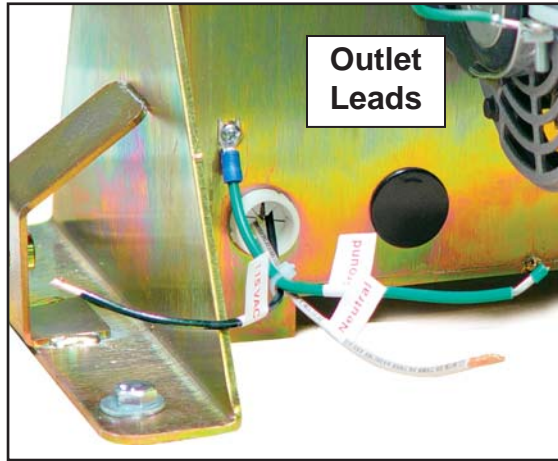

Figure 2



HOOKUP ELECTRICAL POWER

Figure 3



NOTE: Hookup your electrical 15 amp wires direct to outlet.

GATE TRAVEL ADJUSTMENT

Figure 4

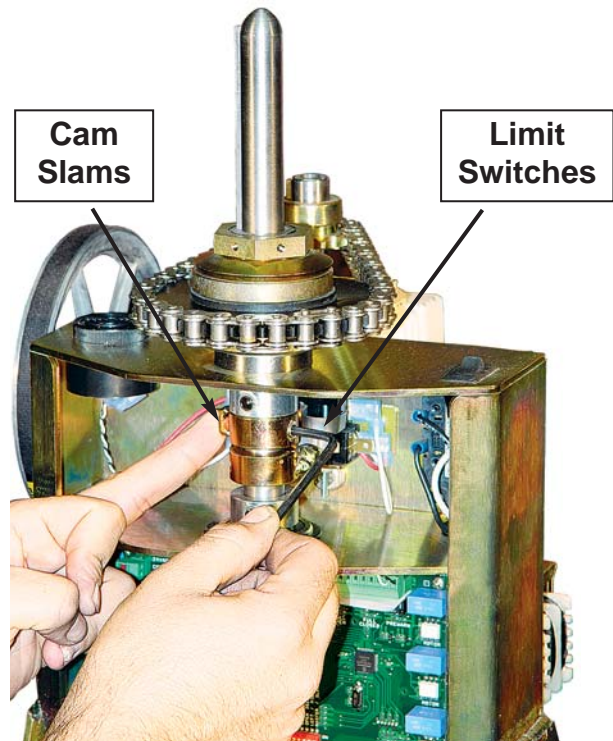

Gate travel is adjusted by loosening the limit Cams and positioning them until proper gate travel has been achieved.

STANDARD INSTALLATION FOR GATES FROM 4' TO 12' IN LENGTH

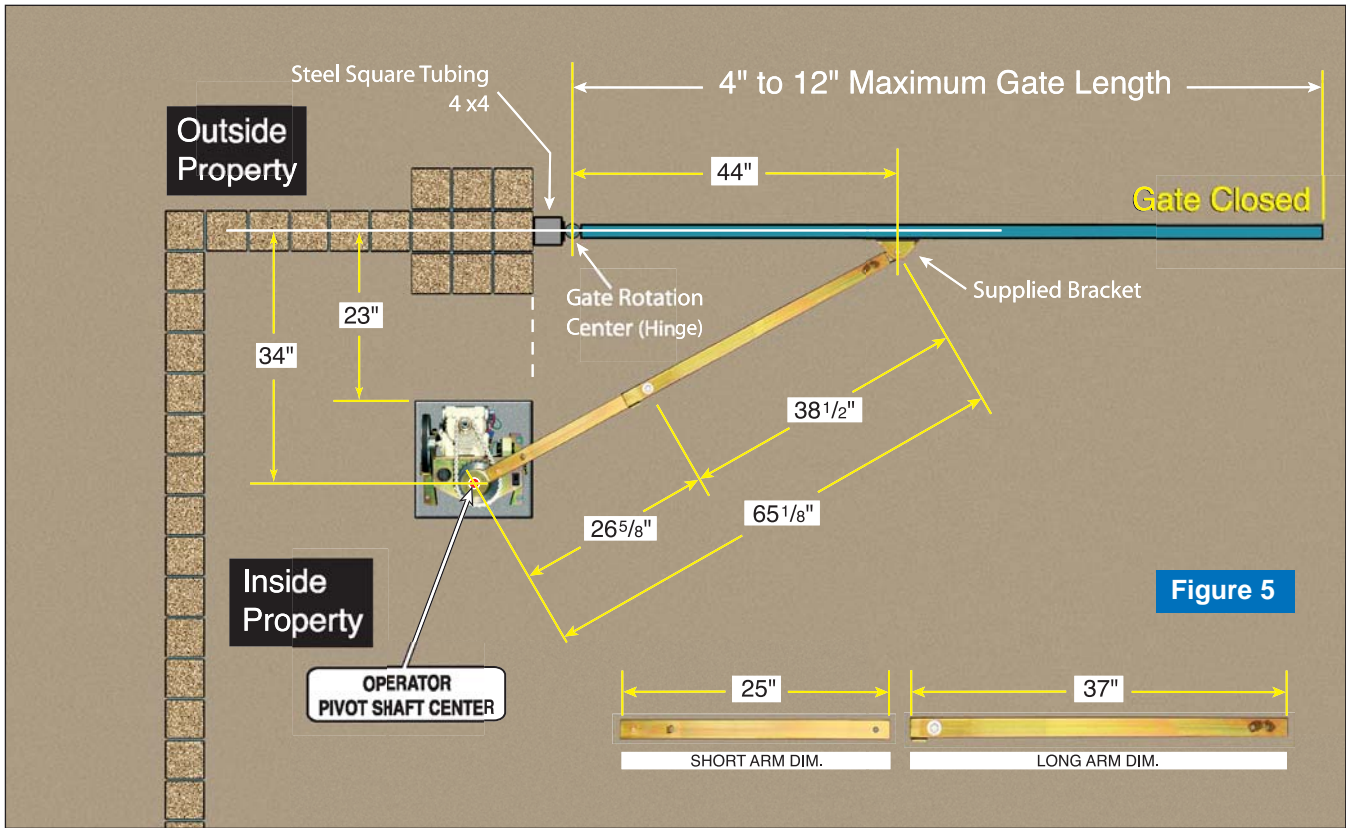

SPACE REQUIRED FOR A STANDARD GATE IN THE OPEN POSITION

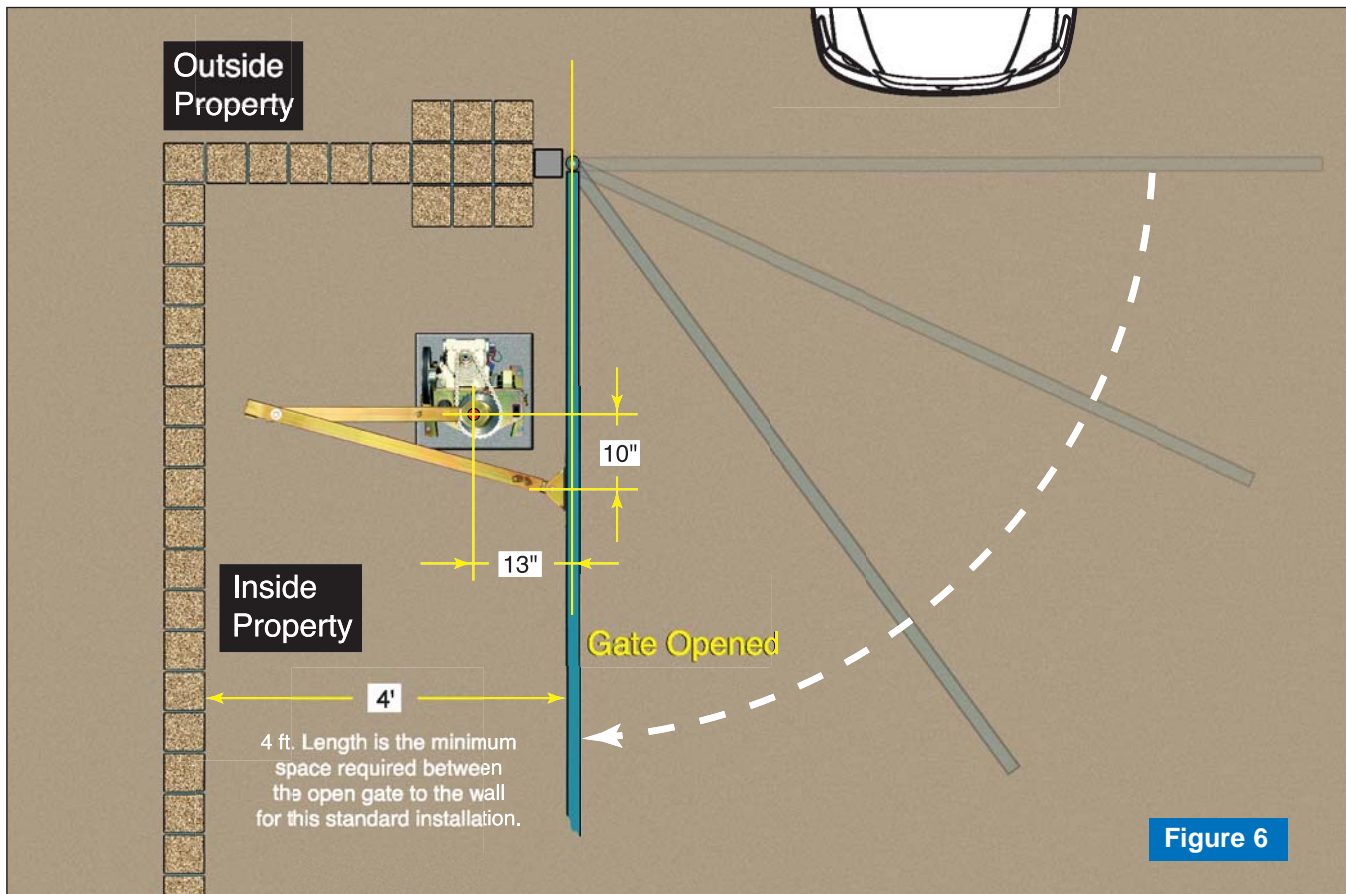

COMPACT INSTALLATION FOR GATES UP TO 10' IN LENGTH

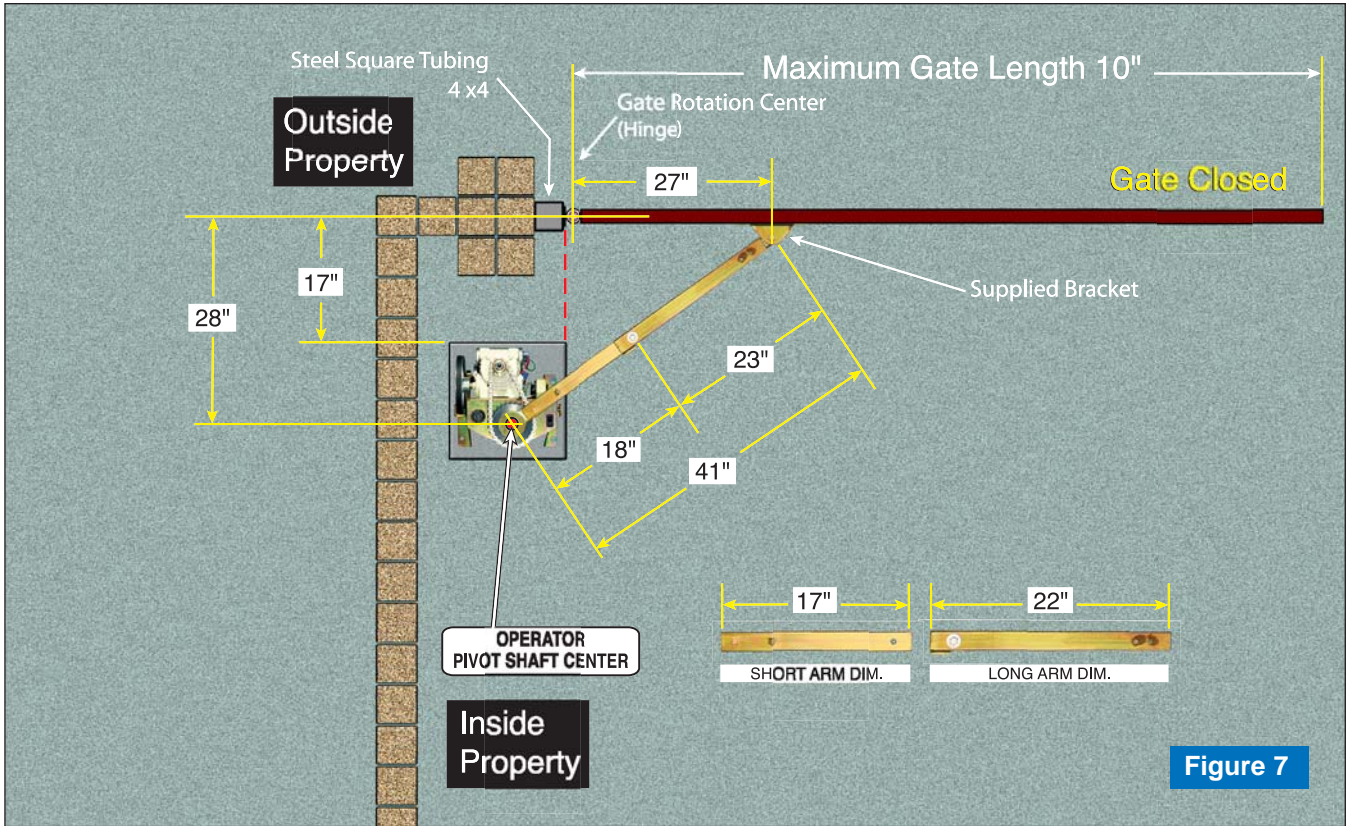

MINIMUM SPACE REQUIRED FOR COMPACT INSTALLATION

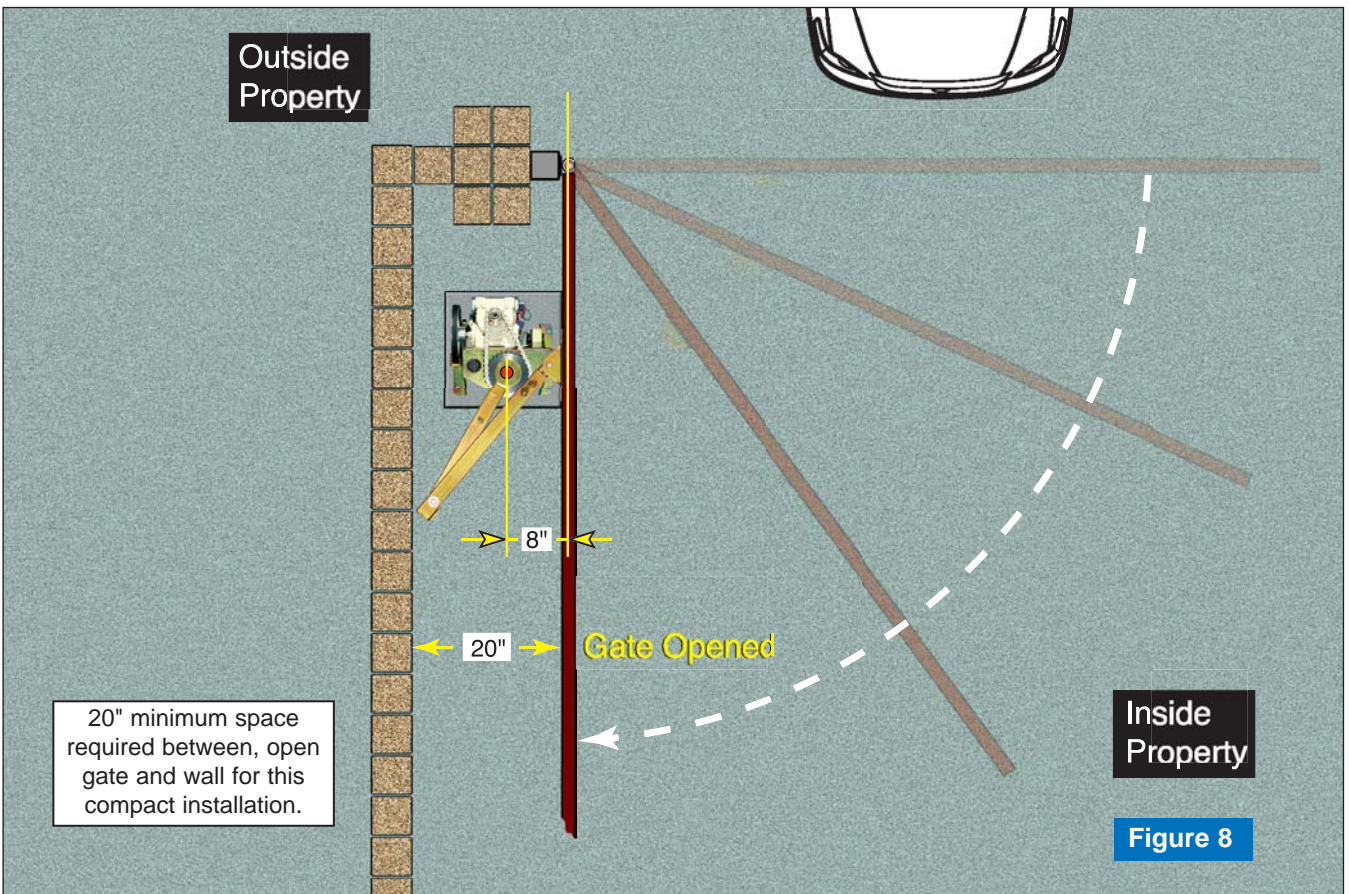

SENSOR INSTALLATION

Ramset Gate Operators should not be installed without non-contact sensing devices such as Loop Detectors, photo electric sensors or the equivalent.

WARNING:

A non-contact sensor (photoelectric sensor or equivalent) and a contact sensor (edge device or equivalent) is required on each individual installation to comply with UL325.

Reversing Loops on the ground floor, prevents gate from closing when vehicle is in loop area.

Exit Loops on the ground floor, opens gate when vehicle crosses loop area.

Photoelectric Safety Sensor (Photo Eye) prevents the gate from closing when any object interrupts the beam.

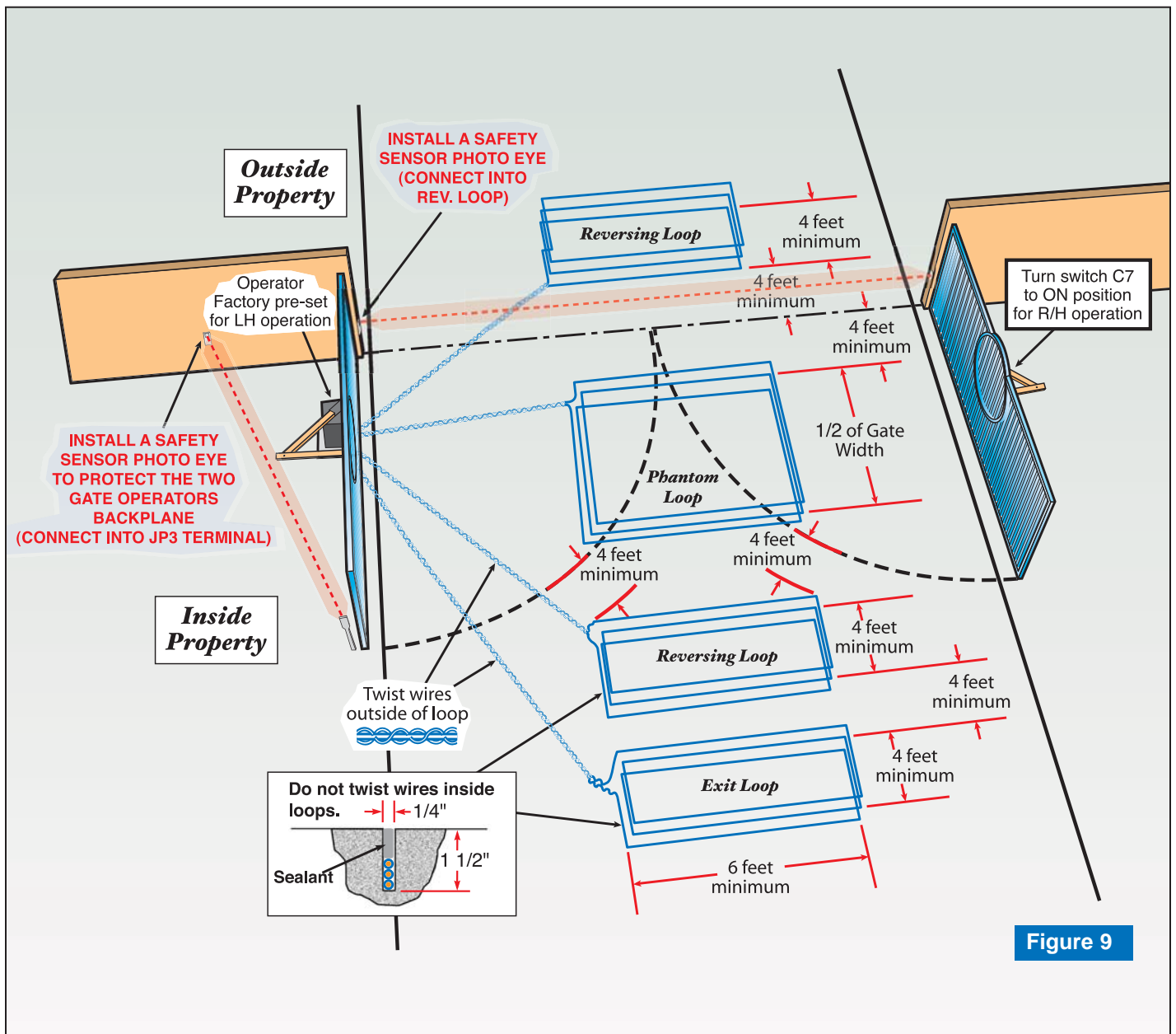

Figure 9

PUSHBUTTON CONTROLS

Three pushbuttons are located under the dip switches for operation of the gate (see Figure 11). The **opening**, **stop** and **closing** buttons can be utilized to set limit switches and verify proper system operation when installing or servicing an operator.

Opening

Pressing this button will cause the gate to open.

Stop

Pressing this button will cause the gate to stop moving.

Closing

Pressing this button will cause the gate to close.

Reset E.R.D. Board

Push all three pushbuttons for approximately 5 seconds. All three L.E.D.'s should blink.

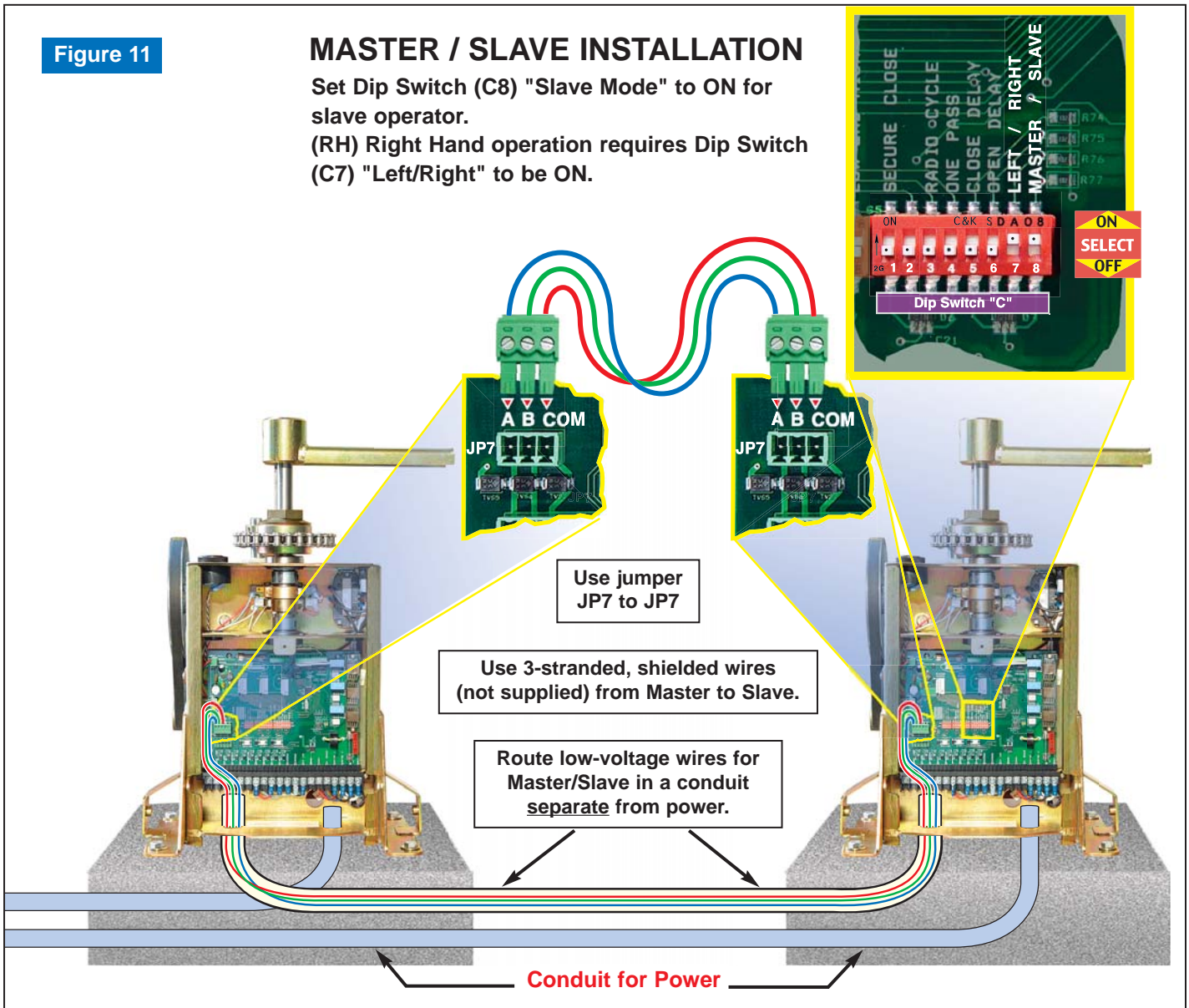
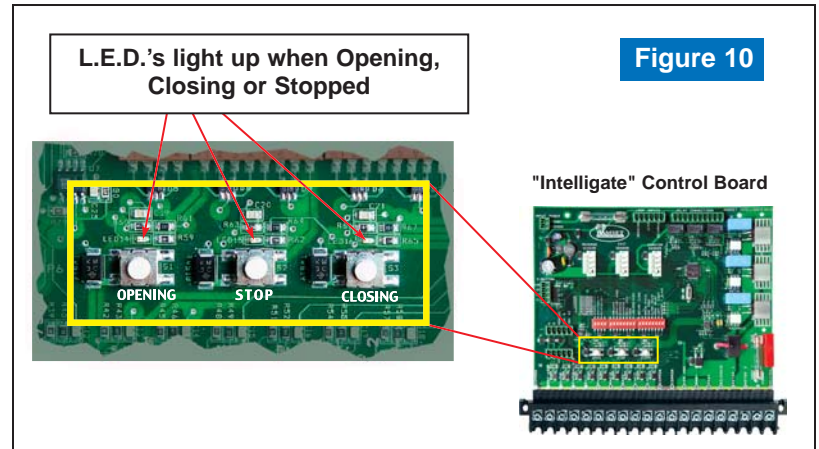

DIP SWITCH CONFIGURATION

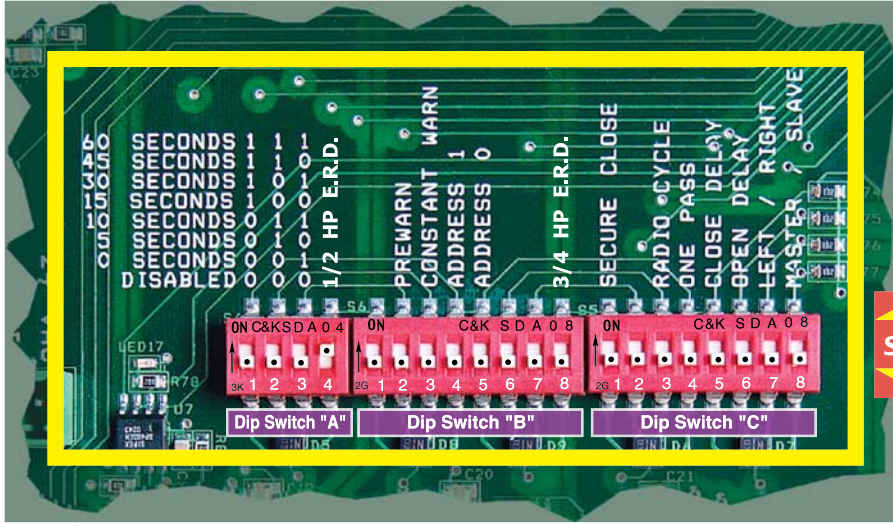

Figure 12

Dip Switch Up for "ON"
 Dip Switch Down for "OFF"

DIP SWITCH "A"

Dip Switch "A" 1, 2 & 3; AUTOMATIC TIMER TO CLOSE GATE

'0' is "OFF"	'1' is "ON"			Gate Open Duration:
Switch	1	2	3	
	1	1	1	60 seconds
	1	1	0	45 seconds
	1	0	1	30 seconds
	1	0	0	15 seconds
	0	1	1	10 seconds
	0	1	0	05 seconds
	0	0	1	00 seconds
	0	0	0	Disabled - command required to close

Dip Switch "A" 4; 1/2 HP E.R.D.

Sw.	Function:
OFF	Most sensitive or when using 3/4 hp motor.
ON	Stronger (Less sensitive) E.R.D. for 1/2 hp motors.

DIP SWITCH "B"

Dip Switch "B" 1; Not in use at this time.

Leave in the 'Off' position.

Dip Switch "B" 2; "PREWARN"

Sw.	Pre Warning Relay:
OFF	Normal Operation
ON	Adds a 3-second delay before the gate moves in any direction. During This 3 second delay the PREWARN Relay maintains a closed contact.

Dip Switch "B" 3; "CONSTANT WARN"

(Constant warning when gate is in motion).

Sw.	Function:
OFF	No effect.
ON	Triggers the prewarn relay to maintain a closed contact while gate is in motion.

Dip Switch "B" 4 & 5; "ADDRESS 1 & ADDRESS 0"

Up to four separate entrance addresses are available for installations with multiple entrance or exit locations. Master and slave gates that work together should be set to the same address. (Side gates use the address setup)

Sw. 4	Sw. 5	Function:
0	0	Default - Entrance 1
0	1	Entrance 2
1	0	Entrance 3
1	1	Entrance 4

Dip Switch "B" 6; Not in use at this time.

Leave in the 'Off' position.

Dip Switch "B" 7; Not in use at this time.

Leave in the 'Off' position.

Dip Switch "B" 8; 3/4 HP E.R.D.

Sw.	Function:
OFF	Most sensitive or when using a 1/2 hp motors.
ON	Stronger (Less sensitive) E.R.D. for 3/4 hp motors.

DIP SWITCH "C"

Dip Switch "C" 1; "SECURE CLOSE"	
Sw.	Function:
OFF	Normal Operation
ON	When power is lost, then regained, control board checks status of the gate. If open and safety devices are cleared, gate will close automatically.



WARNING:

When installing or servicing an operator, make sure switch **"C" 1 is 'Off'**. If switch "C" 1 is 'On', the gate will move when power is applied and severe injury may occur.

Dip Switch "C" 2; Not in use at this time.	
	Leave in the 'Off' position.

Dip Switch "C" 3; "RADIO CYCLE"	
Sw.	Function:
OFF	Normal Operation - gate only opens and closes on the limit switches. If the gate is in travel then it will always open.
ON	Cycle mode - gate opens and closes on the limit switches, but if in travel, then it will stop with a first command and reverse with a second command.

Dip Switch "C" 4; "ONE PASS"	
Sw.	Function:
OFF	Normal Operation - fully opens and closes
ON	One pass mode - The gate will open until "the reversing loop" is initially activated and then cleared, the gate will then close. If the "reversing loop" is then activated again, before the gate is fully closed, the gate will stop until the "reversing loop" is cleared, then continue to close.

Dip Switch "C" 5; "CLOSE DELAY"	
	One second delay on the closing of the gate.

Dip Switch "C" 6; "OPEN DELAY"	
	One second delay on the opening of the gate.

Dip Switch "C" 7; "LEFT / RIGHT"	
Sw.	Function:
OFF	Left hand installations - All operators come factory set for left hand operation.
ON	Right hand installations - Reverses motor & limit switches without moving any wires.

Dip Switch "C" 8; "SLAVE MODE" Master/Slave configuration	
Sw.	Function:
OFF	Master mode - single gate operation. All peripheral devices are to be connected to the master operator.
ON	Slave mode - used to synchronize operation between two gates. Commands are received from the master through a 3-wire, shielded cable. (Not provided with unit).

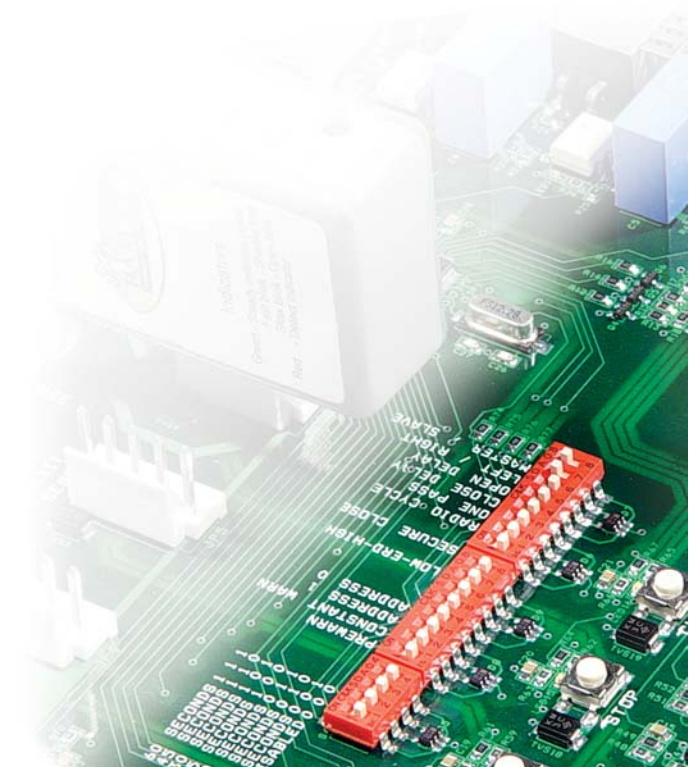

TERMINAL STRIP CONNECTION FOR OPTIONAL ACCESSORIES

Figure 13

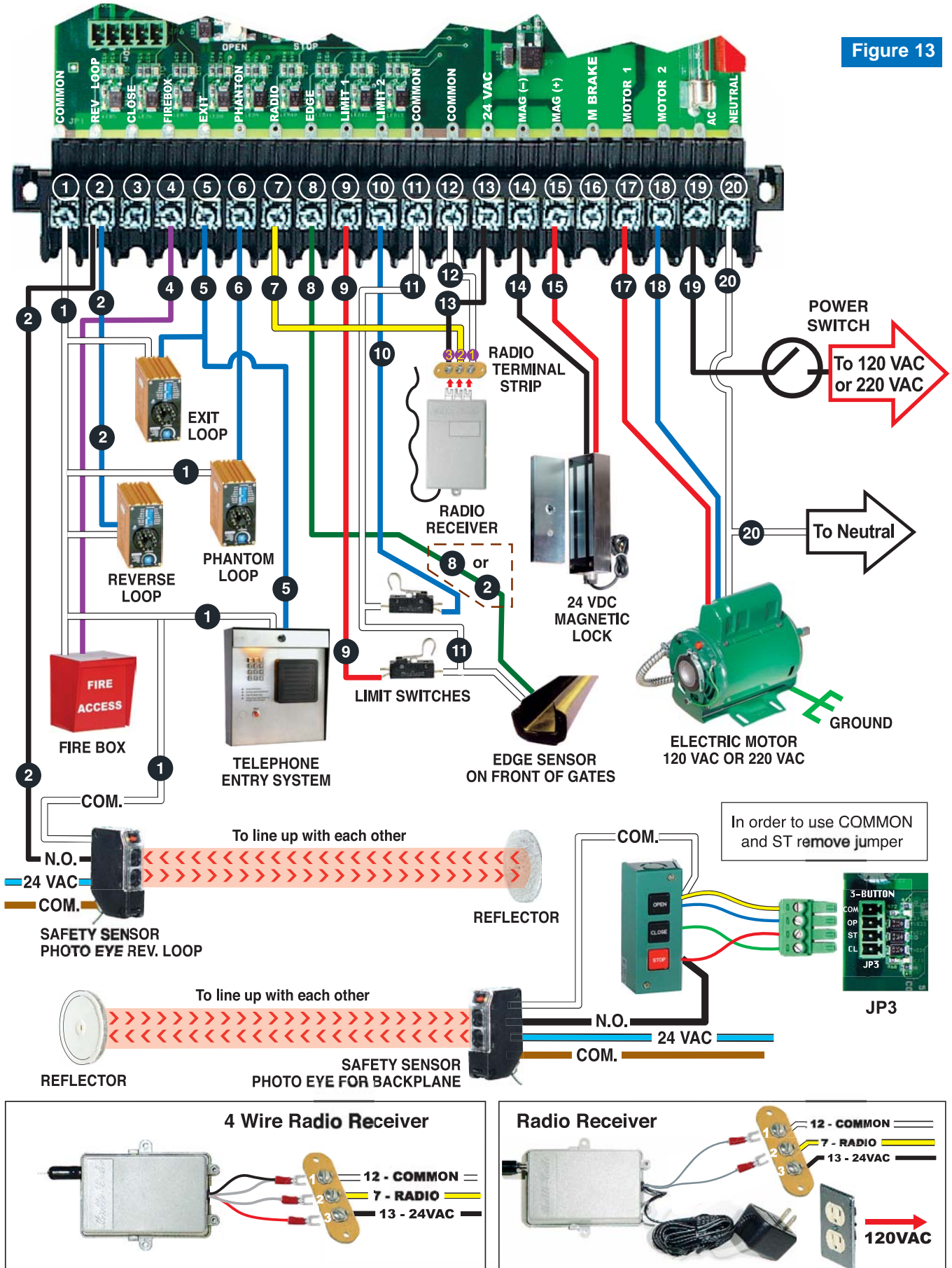

TERMINAL STRIP CONNECTIONS

Terminal # 1 - COMMON:

Low voltage common.

Terminal # 2 - REV LOOP:

Stops the gate from closing. If the gate is open, it holds the gate open. If the gate is closing, it stops and reopens the gate. If the gate is closed, the gate will remain closed. The function can be altered with Dip Switch "C" 4 (see "Dip Switch Configuration"). Used with loop detectors, photo eyes, safety edges on front side of gate etc. Becomes active with a closed contact to common.

Terminal # 3 - CLOSE:

Closes the gate. Used with three button stations or pushbuttons. Becomes active with a closed contact to common.

Terminal # 4 - FIREBOX:

Opens the gate. Used with fire department key switches & controls. Opens with closed contact to common. Closes immediately when closed contact on common is removed.

Terminal # 5 - EXIT:

Opens the gate. Used with loop detectors, photo eyes, keypads, phone entry systems, three-button stations...etc. Becomes active with a closed contact to common.

Terminal # 6 - PHANTOM:

Keeps the gate open when the open limit switch is activated. Used with loop detectors. Becomes active with a closed contact to common.

Terminal # 7 - RADIO:

Operation depends on dip switch "C" 3 (See "Dip Switch Configuration"). Used with an RF receiver or pushbutton. Becomes active with a closed contact to common.

Terminal # 8 - EDGE:

When triggered the gate will stop. The gate will remain stopped until the detector is cleared. Once the detector is cleared, the operator will resume normal operation. If triggered twice before reaching a limit switch, the alarm will

sound for 6 minutes and the control board will not accept any commands. After the 6 minutes the 24 VDC is removed from the alarm connection and the board resets to normal operation.

Used with safety edge mounted on post or back of gate.

Terminal # 9 and 10 - LIMIT 1 & LIMIT 2:

Direction depends on Dip Switch "C" 7 (See "Dip Switch Configuration"). Stops the motor from moving in one direction. These wires are preset in factory and should not be moved. Becomes active with a closed contact to common.

Terminal # 11 and 12 - COMMON:

Low voltage common.

Terminal # 13 - +24 VAC:

Provides 24 VAC for peripheral accessories.

Terminal # 14 and 15 - MAG (-) & MAG (+):

Supplies 24 VDC to a Magnetic Lock when the gate is closing or closed. If gate is opening or opened, then no power is supplied. Leave open if not used.

Terminal # 16 - M BRAKE:

Used ONLY on the Ram 50 Operator. If while the gate is closed someone or something tries to manually open the gate without a proper signal (keypad, exit loop, radio signal...), the motor will lock up for 6 minutes. After the 6 minutes, the operator will then secure close the gate.

Terminal # 17 and 18 - MOTOR 1 & MOTOR 2:

Supplies power to the motor. Direction depends on Dip Switch "C" 7 (see "Dip Switch Configuration"). These wires are preset and connected in the factory and should not be moved.

Terminal # 19 and 20 - AC HOT & NEUTRAL:

110 VAC or 220 VAC to power the operator. Voltage is predetermined at factory and cannot be changed by the installer or technician.

RAMSET "INTELLIGATE" CONTROL BOARD

Introduction:

Ramset's "Intelligate" Control Board works with Sliding, Swinging and Overhead vehicular gate operators. It is controlled by a programmable microprocessor that reads and precisely executes all functions of the Control Board. The Control Board is powered by a separate mounted 18 VAC transformer. This allows no neces-

sary board modifications between 110 VAC and 220 VAC single-phase applications. Some of the functions of the Control Board are: 0 - 60 seconds automatic close timer, self adjusting E.R.D. with low and high setting, constant warning, prewarning, secure close, one pass, open & close delay, left/right hand operation, plug-in loop detectors and RS485 three wire master/slave connection.

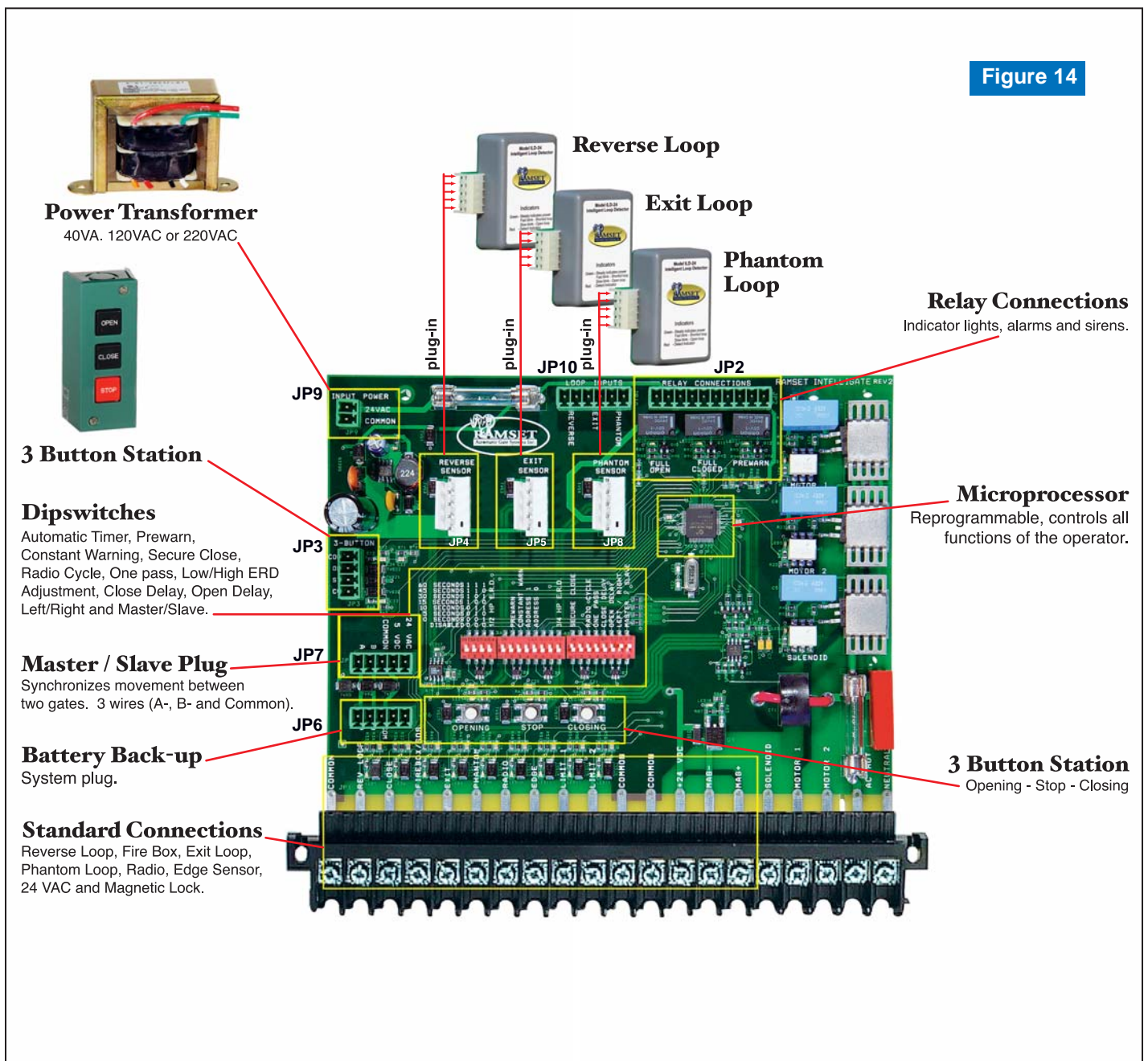

WIRE BOARD CONNECTIONS



JP9 - Input Power:

1,2) 24 VAC power.

Connection from external transformer to power Control Board.



JP3 - 3 Button:

1) Close 2) Stop 3) Open 4) Common

Used with a 3-button station to open, stop, and close the gate. The open and close are normally open connections and the stop is a normally closed connection, remove jumper wire when connecting 3 button station. Common and stop are also used with a photo eye used to protect the back-plane of the operators.

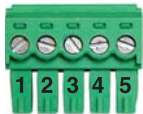

JP7 - Master/Slave plug:

1) A 2) B 3) Common 4) 5 VDC
5) 24 VAC.

Used to synchronize the operation between two gates. A three-wire, Shielded cable is needed to run from the A, B, & Common (JP7) of the master P.C.B. to the A, B, & Common (JP7) of the slave P.C.B.

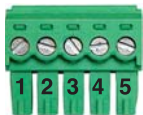

JP6 - Battery back-up plug:

1) A 2) B 3) Common 4) 5 VDC
5) 24 VAC.

Use this plug when using optional battery back-up system, Ramset Keypad.

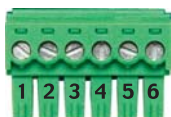

JP10 - Loop Inputs:

1-2) Reverse 3-4) Exit 5-6) Phantom

Use with ILD-24 Loop wires should be connected to this plug.

JP4, JP5 & JP8 - Reverse, Exit & Phantom Sensor:

Used with the Ramset ILD-24 plug-in loop detector. The Loop wires should be connected into the "LOOP INPUTS" plug.



JP2 - Relay Connections:

1) 24 VDC. 5) Relay Common
2) 24 VAC 6) Fully Closed-N.C.
3) 5 VDC 7-8) Constant/Prewarn
4) Fully Open-N.O. 9-10) E.R.D. Alarm.

If E.R.D. is triggered twice before reaching a limit, 24 VDC is supplied to sound an alarm (included with operator).

Fully Open N.O. (works with relay common) -

Relay rated at 125 VAC, 2 amps. Normally open connection. Open contact occurs until the open limit is triggered. When the open limit is triggered, a closed contact occurs.

Relay Common - Relay rated at 125 VAC, 2 amps.

The common of the Fully Closed N.C. relay and the Fully Open N.O. relay.

Fully Closed N.C. (works with relay common) -

Relay rated at 125 VAC, 2 amps. Normally closed connection. Closed contact occurs until the closed limit is triggered. When the closed limit is triggered, an open contact occurs.

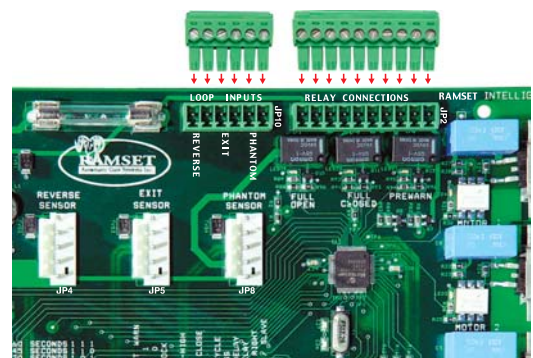

RAM 30

Exploded View

Figure 15

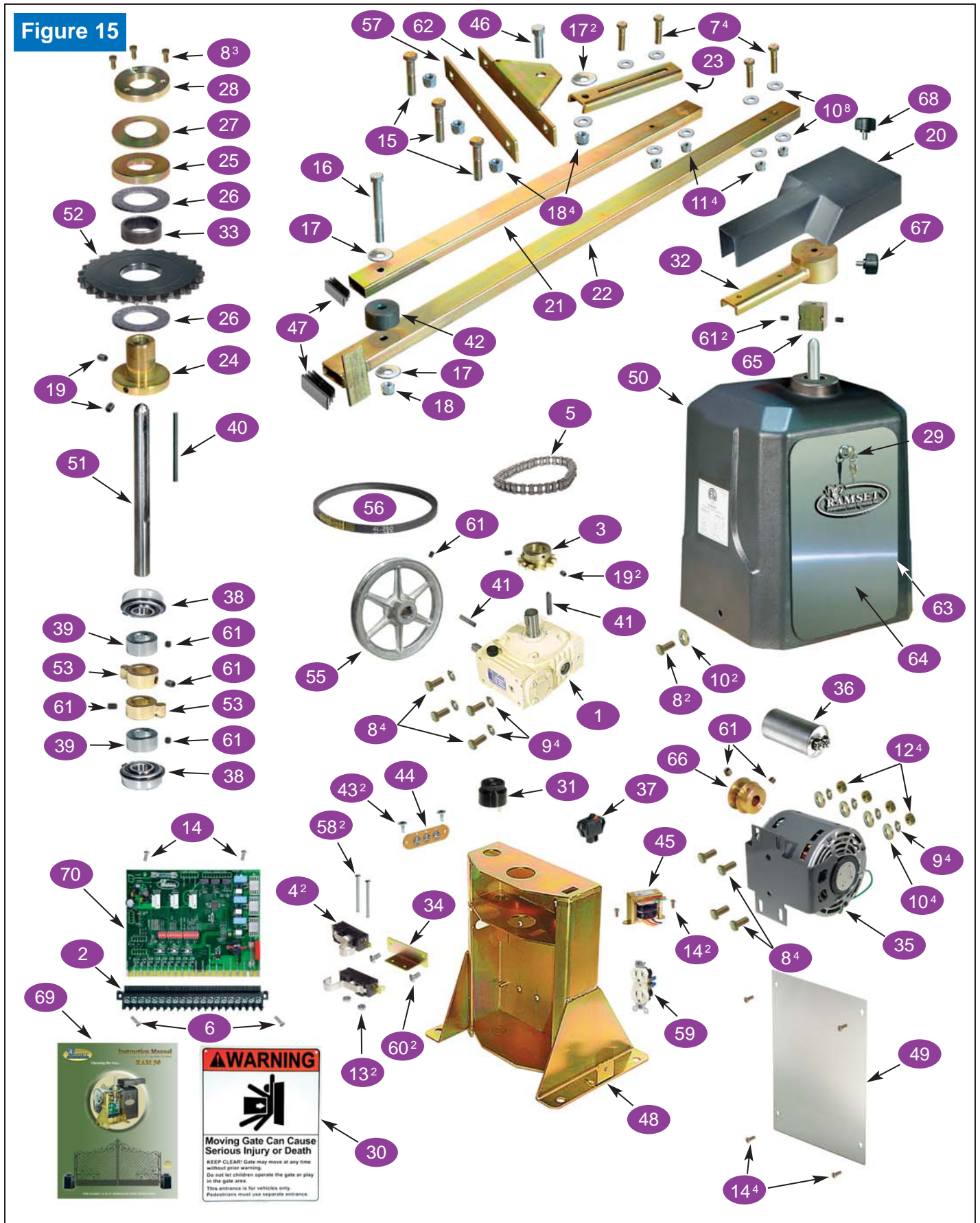

BILL OF MATERIAL FOR: RAM 30

ITEM	PART #	PART DESCRIPTION	RAM 30		
1	50-027	Gear Reducer Size 40 60:1	1		
2	50-039	20 Pin Edge Connector	1		
3	50-050	40 b 12 7/8" Sprocket	1		
4	50-069	Limit Switch 00h-3	2		
5	50-084	# 40 Drive Chain	1		
6	50-091	# 6 x 1" Machine Screw	2		
7	50-092	3/8-16 x 1 1/2" Hex Head Bolt	4		
8	50-095	5/16-18 x 3/4" Hex Head Bolt	13		
9	50-096	5/16" Lock Washer	8		
10	50-097	5/16" Flat Washer	14		
11	50-103	3/8-18 Hex Head Lock Nut	4		
12	50-104	5/16" Hex Head Nut	4		
13	50-105	# 6 Hex Head Nut	2		
14	50-107	# 6 x 3/8" Machine Screw	8		
15	50-110	1/2-14 x 2 1/2" Hex Head Bolt	3		
16	50-111	1/2-14 x 3 1/2" Hex Head Bolt	1		
17	50-112	1/2" Flat Washer	4		
18	50-113	1/2-14 Nylon Lock Nut	5		
19	50-114	1/4-20 Socket Head Screw	4		
20	50-115	Polyethylene Cup Cover	1		
21	50-117	1" x 2" x 32" Rectangular Metal Tube	1		
22	50-118	1" x 2" x 42" Rectangular Metal Tube	1		
23	50-126	Channel	1		
24	50-127	2 1/2" Torque Limited Arbor	1		
25	50-128	2 1/2" Torque Limited Washer	1		
26	50-129	2 1/2" Torque Limited Friction Disc	2		
27	50-130	2 1/2" Torque Limited Tension Washer	1		
28	50-131	1-3/4" Torque Limited Nut	1		
29	50-149	Access Door Lock	1		
30	50-151	Warning Sign for Gate	2		
31	50-168	Horn Alarm	1		
32	50-172	3 1 1/2" Clamp Release	1		
33	50-181	Torque Limited Bushing	1		
34	50-183	Limited Switch Bracket	1		
35	50-200	1/2 Hp 115 VAC Electric Motor	1		
36	50-205	Capacitor	1		
37	50-215	Rocker Switch	1		
38	50-247	3/4" Sealed Ball Bearing	2		
39	50-253	3/4" Collard Shaft	2		
40	50-263	1/4" x 5" Key Way	1		
41	50-265	3/16" x 3/4" Key Way	2		
42	50-275	1 1/2" UHMW Spacer	1		
43	50-295	#8 Self-Tap Sheet Metal Screw	2		
44	50-299	Radio Receiver Terminal	1		

TROUBLESHOOTING TABLE

CONDITION	POSSIBLE CAUSES	SOLUTION
NO LIGHTS ARE 'ON'	<ol style="list-style-type: none"> 1. Circuit breaker popped. 2. 1/2 amp. fuse blown. 3. Power supply damaged on control Board. 	<ol style="list-style-type: none"> 1. Reset circuit breaker. 2. Replace 1/2 amp. fuse. 3. Return Control Board for repair.
GATE MOVES A COUPLE OF FEET AND THEN REVERSES	<ol style="list-style-type: none"> 1. E.R.D. too sensitive. 	<ol style="list-style-type: none"> 1. A) for 1/2 hp motors: turn dip switch "A" 4 'On'. B) for 3/4 hp motors: turn dip switch "B" 8 'On'.
"EXIT" L.E.D. IS ALWAYS 'ON'	<ol style="list-style-type: none"> 1. Faulty accessory connected to the "Exit". 	<ol style="list-style-type: none"> 1. Disconnect all accessories, including plug-ins, using the "Exit" input. If problem persist, contact Ramset.
"REV LOOP" L.E.D. ALWAYS 'ON'	<ol style="list-style-type: none"> 1. Faulty accessory connected to the "Rev Loop". 	<ol style="list-style-type: none"> 1. Disconnect all accessories, including plug-ins, using the "Rev Loop" input. If problem persist, contact Ramset.
"RADIO" L.E.D. ALWAYS 'ON'	<ol style="list-style-type: none"> 1. Stuck button on Transmitter 2. Faulty Receiver. 	<ol style="list-style-type: none"> 1. Check all transmitters. 2. Remove receiver. If problem persist, contact Ramset.
GATE DOESN'T OPEN	<ol style="list-style-type: none"> 1. Radio L.E.D. 'On'. 2. 10 amp. fuse blown. 3. Opening accessory not functioning. 	<ol style="list-style-type: none"> 1. See above symptoms/solutions. 2. Check/replace 10 amp. fuse. 3. Check/replace opening accessory.
GATE DOESN'T CLOSE	<ol style="list-style-type: none"> 1. No lights are 'On'. 2. Exit, Rev Loop, Radio L.E.D. 'On'. 3. 10 amp. fuse blown. 4. Thermal/overload button popped on motor. 	<ol style="list-style-type: none"> 1. See above symptoms/solutions. 2. See above symptoms/solutions. 3. Check/replace 10 amp. fuse. 4. Reset thermal/overload button on the back of the motor.
GATE DOESN'T CLOSE AUTOMATICALLY	<ol style="list-style-type: none"> 1. Dip switches "A" 1-3 are all 'Off'. 2. Dip switch not on all the way. 	<ol style="list-style-type: none"> 1. Set dip switches "A" 1-3 for auto close. 2. Turn off dip switches "A" 1-3, then turn the appropriate switches back 'On'.
GATE AUTOMATICALLY OPENS, BUT DOESN'T AUTOMATICALLY CLOSE	<ol style="list-style-type: none"> 1. Motor direction wrong. 	<ol style="list-style-type: none"> 1. Turn on dip switch "C" 7 (left/right).
RADIO/RECEIVER HAS NO RANGE	<ol style="list-style-type: none"> 1. Signal blocked. 2. Area not suitable for type of Receiver. 	<ol style="list-style-type: none"> 1. Make sure antenna is in proper position & not shorted to chassis. 2. May need to change to long range receiver.

GATE ENTRANCE SAFETY PRECAUTIONS



1. Never let children operate or play with gate controls. Keep the controls away from children.
2. The entrance is for vehicles only. Pedestrians should use a separate entrance.
3. Always keep people, children and objects away from the gate while the gate is in operation.
No one should cross the area of a moving gate.
4. All opening devices, (such as a keypad, cardreader...), should not be installed close to the gate, where the gate could possibly cause injury.
5. Use warning signs attached on both sides of the gate.



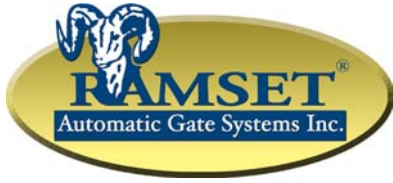

Opening the way...

Important information for the homeowner

Ask your technician about all the features of our new Ramset operator.

Safety devices, such as reverse loops, phantom loops, photo eyes, or miller edges must be installed on your gate before the operator may be used. Ask your technician which safety devices best suit your safety needs.

Read your warranty certificate and fill out your warranty extension card. Return the warranty card, via certified mail, to Ramset within 90 days of purchase:

Ramset Automatic Gate Services, Inc.
9116 De Garmo Ave.
Sun Valley, CA. 91352

Never let children operate or play with gate controls. Keep the controls away from children.

The entrance is for vehicles only. Pedestrians should use a separate entrance.

Always keep people, children and objects away from the gate while the gate is in operation. No one should cross the area of a moving gate.

Use the emergency release only when the gate is not moving. Make sure when using the foot release or hand crank, the circuit breaker for the operator is turned off.

Have the technician give you a demonstration of how to use the emergency release.

Keep gates properly maintained. Have a qualified gate technician service the gate operator and gate hardware every six months to a year. This includes checking of safety devices, E.R.D. and battery back up systems.

Warning signs must be placed on every gate in a highly visible area.

To reset the audible alarm on the gate operator you must turn the circuit breaker for the operator off for approximately 10 seconds, then back on. An exterior switch or button can also be installed on the operator to shut off the audible alarm.

Always keep a good relationship with your technician and keep his or her number handy for future maintenance or emergencies.

***Ramset wishes to thank you for trusting us
to meet your gate operator needs.***

RAMSET OPTIONAL ACCESSORIES



Ramset Mounting Post for Access Control



Ramset Remote Control Transmitter



Ramset Radio Receiver



Ramset Fire Box
EMERGENCY ENTRY BOX



Ramset Key Switch Box



Ramset ILD-24 Plug-in Loop Detectors



RKLE
Ramset Keyless Entry System



Ramset Magnetic Lock



Ramset RPI
Provides power for a 1/2 hp gate operator and accessories. For approx. 50 cycles.



Opening the way...