

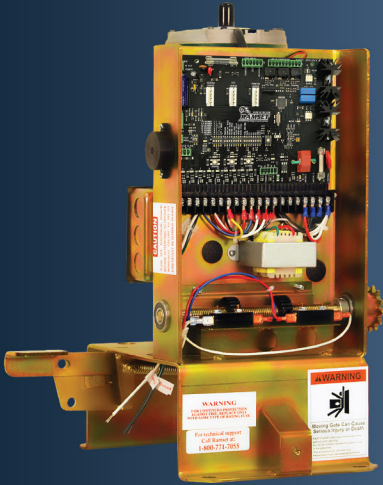

# Instruction Manual

## High Traffic Sliding Gate Operator

*Opening the way...*



**RAM 100**

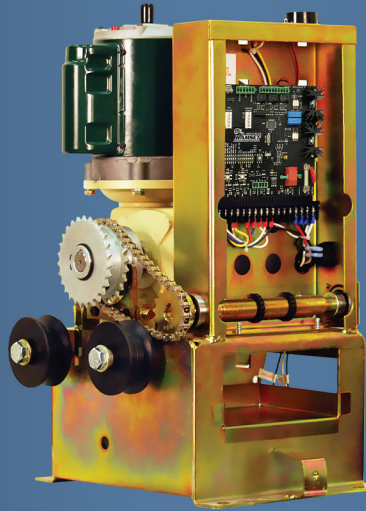

**RAM 1000**

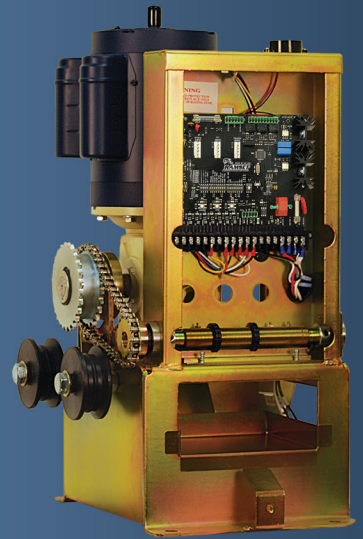

**RAM 5500**



FOR CLASS I, II, III, IV VEHICULAR GATE OPERATORS





# TABLE OF CONTENTS

- Important Safety Requirements & Instructions ..... 1
- Responsibilities Of Installers And Technicians..... 2-3
- Important Safety Requirements By UL Standards..... 4
- UL Gate Classification/ Recommended Electrical Connection/ Recommended Wire Gauge ..... 5
- General Specifications..... 6
- RAM 100 Installation Specifications ..... 7
- RAM 100 Front Installation/ Foot Pedal Installation ..... 8
- RAM 1000/5500 Installation Specifications ..... 9
- RAM 1000/5500 Types of Installations..... 10
- Loop Sensor Installation/ Gate Travel Adjustment ..... 11
- Entrapment And Safety Protection ..... 12-13
- Intelligate LED Layout ..... 14
- Pushbutton Controls/Primary/Secondary Installation ..... 15
- Dip Switch Configuration ..... 16-17
- Terminal Strip Connections ..... 18-19
- Plug Connections ..... 20
- Plug Connections/Wiring Diagrams..... 21
- Parts Diagram - RAM 100 ..... 22
- Parts Diagram - RAM 1000/5500 ..... 23
- Bill Of Materials ..... 24-25
- Gate Entrance Safety Precautions ..... 26
- Important Information For The Homeowner ..... 27
- Troubleshooting Table..... 28

RAM 100 • 1000 • 5500

 **WARNING** **DO NOT INSTALL THIS GATE OPERATOR SYSTEM UNLESS YOU ARE A TRAINED, EXPERIENCED GATE TECHNICIAN**

## IMPORTANT SAFETY REQUIREMENTS & INSTRUCTIONS

1. Read, understand & follow the instruction manual.
2. Never let children operate or play with gate controls. Keep the remote control away from children.
3. Always keep people and objects away from the gate. No one should cross the path of the moving gate.
4. Test the vehicular gate operator monthly. The gate MUST reverse on contact with a rigid object or stop when an object activates the non-contact sensors. After adjusting the limit of travel, retest the vehicular gate operator. Failure to adjust and retest the vehicular gate operator properly can increase the risk of injury or death.
5. Use the Emergency release only when power switch or circuit breaker has been turned off. Using the emergency release during a power failure can be a hazard if power is abruptly restored.
6. KEEP GATES PROPERLY MAINTAINED. Read the owner's manual. Have a qualified service person make repairs to gate hardware.
7. The entrance is for vehicles only. Pedestrians must use separate entrance.
8. SAVE THESE INSTRUCTIONS.

## RESPONSIBILITIES OF INSTALLERS AND TECHNICIANS

**\*\* RAMSET GATE OPERATORS SHOULD ONLY BE INSTALLED, MAINTAINED AND SERVICED BY QUALIFIED TECHNICIANS WHO HAVE APPROPRIATE TRAINING WITH GATE OPERATORS\*\***

### INSTALLATION

- READ AND UNDERSTAND THE INSTRUCTION MANUAL BEFORE ATTEMPTING ANY INSTALLATION.
- USE THE PROPER OPERATOR. TAKE THE FOLLOWING INTO CONSIDERATION:
  - CATEGORY (SWING, SLIDE OR OVERHEAD)
    - TYPE (STANDARD, UPHILL, COMPACT , CANTILEVER ...ETC) ALL MEASUREMENTS, SPECIFICATIONS AND CAPABILITIES IN THIS MANUAL ARE FOR STANDARD INSTALLATIONS. ALL OTHER TYPES OF INSTALLATIONS LOWER THE CAPABILITIES OF THE OPERATOR.
  - GATE WEIGHT
  - TRAVEL LENGTH
  - CLASS (SEE PAGE 5)
- DO NOT EXCEED THE EQUIPMENT SPECIFICATIONS AND CAPABILITIES

### SAFETY

- SAFETY IS THE PRIMARY CONCERN WHEN INSTALLING A GATE OPERATOR.
- INSURE A SAFE AND PROPER INSTALLATION FOLLOWING ALL BUILDING, FIRE, ELECTRICAL, PROPERTY MAINTENANCE, ASTM F 2200 AND UL 325 SAFETY CODES.
- ONLY USE UL 325 COMPLIANT ACCESSORIES AND EQUIPMENT.
- APPROVED ANTI-ENTRAPMENT DEVICES:
  - MILLER'S EDGE "PRIMEGAURD", MILLER'S EDGE "REFLECTI-GAURD", MILLER'S EDGE "WIRELESS EDGE LINK", MILLER'S EDGE "THE SOLUTION", EMX "IRB-MON".
- ALL EXPOSED PINCH POINTS ARE ELIMINATED OR GUARDED.
- ALL EXPOSED ROLLERS ARE GUARDED.
- WHEN SERVICING A GATE OPERATOR ALWAYS PERFORM AN INSPECTION OF THE ENTIRE INSTALLATION AND MAKE ANY AND ALL SUGGESTIONS, TO THE PROPERTY OWNER, TO BRING THEIR SYSTEM INTO COMPLIANCE WITH THE CURRENT UL STANDARD.



## RESPONSIBILITIES OF INSTALLERS AND TECHNICIANS cont.

- WARNING SIGNS MUST BE PERMANENTLY AFFIXED TO THE GATE PANEL IN A HIGHLY VISIBLE PLACE THAT CAN BE EASILY SEEN FROM BOTH SIDES OF THE GATE.
- A SEPARATE ENTRANCE IS SUPPLIED FOR PEDESTRIANS. THE OPERATOR IS INTENDED FOR INSTALLATION ONLY FOR GATES USED FOR VEHICLES.
- THE GATE MUST BE INSTALLED IN A LOCATION SO THAT ENOUGH CLEARANCE IS SUPPLIED BETWEEN THE GATE AND ADJACENT STRUCTURES WHEN OPENING AND CLOSING TO REDUCE THE RISK OF ENTRAPMENT.
- ALL CONTROLS MUST BE LOCATED AT LEAST 6 FEET AWAY FROM ANY PART OF THE GATE OPERATOR OR MOVING GATE AT ALL TIMES.
- INTERIOR CONTROL STATIONS SHOULD BE INSTALLED SO THAT THE USER HAS A DIRECT LINE OF SIGHT TO THE GATE AREA BEING CONTROLLED.
- PHOTOCELLS SHOULD BE INSTALLED WITHIN 5 INCHES FROM THE GATE PANEL AND A MAXIMUM HEIGHT OF 27.5 INCHES.
- A PHOTOCELL IS A SAFETY DEVICE FOR PEDESTRIANS ONLY; VEHICLE DETECTORS SHOULD ALWAYS BE USED FOR DETECTION OF MOTOR VEHICLES.
- NO SAFETY DEVICES SHOULD EVER BE BYPASSED, REMOVED OR OMITTED BY THE INSTALLER/TECHNICIAN. A SIGNED WAIVER DOES NOT NULIFY THE INSTALLER/TECHNICIANS LIABILITY DUE TO THE FACT THAT IT HAS NO SUBSTANCE IN LITIGATION INVOLVING AN INJURED PARTY WHO DID NOT SIGN THE WAIVER.
- IF YOU ARE INSTALLING THE OPERATOR ON A GATE THAT DID NOT HAVE AN OPERATOR ON IT, THE GATE MUST CONFORM TO THE CURRENT ASTM F 2200 STANDARDS.
- IF YOU ARE INSTALLING THE OPERATOR ON A GATE THAT ALREADY HAD AN OPERATOR ON IT, THE TECHNICIAN/INSTALLER SHOULD ADVISE THE CUSTOMER OF THE UPGRADES THAT ARE NEEDED TO BRING THE GATE UP TO THE CURRENT ASTM F 2200 STANDARDS.
- WHEN INSTALLING OR WORKING ON A GATE OPERATOR SYSTEM, ALWAYS MAKE SURE THAT THE AREA AROUND YOU IS SECURE. USE CONES, YELLOW CAUTION TAPE OR WHEN POSSIBLE, BLOCK OFF THE DRIVEWAY FROM TRAFFIC.
- WHEN NECESSARY, INSTALL SURGE/LIGHTNING SUPPRESSION AND GROUND RODS.
- ALL AREAS THAT ARE AT RISK OF ENTRAPMENT SHOULD BE PROTECTED BY AN ANTI-ENTRAPMENT DEVICE.
- MAKE SURE TO INSTALL POSITIVE STOPS ON THE FULL OPEN & IF NECESSARY, ON THE FULL CLOSED.
- ALWAYS REMEMBER, YOU ARE THE TRAINED PROFESSIONAL AND WHAT A CUSTOMER WANTS SHOULD NEVER SUPERCEDE SAFETY.

## IMPORTANT SAFETY REQUIREMENTS BY UL STANDARDS

**Prior to installation, the following must be observed: (UL 325.58.8.4)**

**a)** Install the gate operator only when:

1. The operator is appropriate for the construction of the gate and the usage Class of the gate,
2. All openings of a horizontal slide gate are guarded or screened from the bottom of the gate to a minimum of 6 feet (1.83m) above the ground to prevent a 2 ¼ inch (57.2 mm) diameter sphere from passing through the openings anywhere in the gate, and in that portion of the adjacent fence that the gate covers in the open position,
3. All exposed pinch points are eliminated or guarded, and
4. Guarding is supplied for exposed rollers.

**b)** The operator is intended for installation only on gates used for vehicles. Pedestrians must be supplied with a separate access opening. The pedestrian access opening shall be designed to promote pedestrian usage. Locate the gate such that persons will not come in contact with the vehicular gate during the entire path of travel of the vehicular gate.

**c)** The gate must be installed in a location so that enough clearance is supplied between the gate and adjacent structures when opening and closing to reduce the risk of entrapment. Swinging gates shall not open into public access areas.

**d)** The gate must be properly installed and work freely in both directions prior to the installation of the gate operator. Do not over-tighten the operator clutch or pressure relief valve to compensate for a damaged gate.

**e)** For gate operator utilizing Type D protection:

1. The gate operator controls must be placed so that the user has full view of the gate area when the gate is moving,
2. The placard as required by 60.1.6 shall be placed adjacent to the controls,
3. An automatic closing device (such as a timer, loop sensor, or similar device) shall not be employed, and
4. No other activation device shall be connected.

**f)** Controls intended for user activation must be located at least six feet (6') away from any moving part of the gate and where the user is prevented from reaching over, under, around or through the gate to operate the controls. \*\*\*Exception: Emergency access controls only accessible by authorized personnel (e.g. fire, police, EMS) may be placed at any location in the line-of-sight of the gate.

**g)** The Stop and/or Reset button must be located in the line-of-sight of the gate. Activation of the reset control shall not cause the operator to start.

**h)** A minimum of two (2) WARNING SIGNS shall be installed, one on each side of the gate where easily visible.

**i)** For gate operators utilizing a non-contact sensor in accordance with 31.1.1:

1. See instructions on the placement of non-contact sensors for each Type of application,
2. Care shall be exercised to reduce the risk of nuisance tripping, such as when a vehicle, trips the sensor while the gate is still moving, and
3. One or more non-contact sensors shall be located where the risk of entrapment or obstruction exists, such as the perimeter reachable by a moving gate or barrier.

**j)** For a gate operator utilizing a contact sensor in accordance with 31.1.1:

1. One or more contact sensors shall be located where the risk of entrapment or obstruction exists, such as at the leading edge, trailing edge, and postmounted both inside and outside of a vehicular horizontal slide gate.
2. One or more contact sensors shall be located at the bottom edge of a vehicular vertical lift gate.
3. One or more contact sensors shall be located at the pinch point of a vehicular vertical pivot gate.
4. A hardwired contact sensor shall be located and its wiring arranged so that the communication between the sensor and the gate operator is not subjected to mechanical damage.
5. A wireless device such as one that transmits radio frequency (RF) signals to the gate operator for entrapment protection functions shall be located where the transmission of the signals are not obstructed or impeded by building structures, natural landscaping or similar obstruction. A wireless device shall function under the intended end-use conditions.
6. One or more contact sensors shall be located on the inside and outside leading edge of a swing gate. Additionally, if the bottom edge of a swing gate is greater than 6 inches (152 mm) above the ground at any point in its arc of travel, one or more contact sensors shall be located on the bottom edge.
7. One or more contact sensors shall be located at the bottom edge of a vertical barrier (arm).

## UL GATE CLASSIFICATION

### Class I Residential Vehicular Gate Operator (3.19)

A vehicular gate operator (or system) intended for use in garages or parking areas associated with a residence of one-to four single families.

### Class II Commercial/General Access Vehicular Gate Operator (3.4)

A vehicular gate operator (or system) intended for use in a commercial location or building such as a multi-family housing unit (five or more single family units), hotel, garages, retail store or other buildings accessible by or servicing the general public.

### Class III Industrial/Limited Access Vehicular Gate Operator(3.11)

A vehicular gate operator (or system) intended for use in an industrial location or building such as a factory or loading dock area or other locations not accessible by or intended to service the general public.

### Class IV Restricted Access Vehicular Gate Operator (3.20)

A vehicular gate operator (or system) intended for use in a guarded industrial location or building such as an airport security area or other restricted access locations not servicing the general public, in which unauthorized access is prevented via supervision by security personnel.

## RECOMMENDED ELECTRICAL CONNECTION

A 3 wire, 115VAC electrical circuit with a 15 amps independent circuit breaker for single operator and a 20 amps for Primary/Secondary. Ideally, the electrical conduits should exit the concrete under the operator. Low voltage control wires must be run in a separate conduit to the operator.

**NOTE: ALWAYS CONSULT AND FOLLOW ALL LOCAL BUILDING AND ELECTRICAL CODES PRIOR TO INSTALLATION.**

## RECOMMENDED WIRE GAUGE

MODEL	HP	VOLTAGE	RUN	START	12GA	10GA	8GA	6GA
R100/R1000	1/2	115VAC	4.5	5.0	up to 225'	226-370'	371-550'	551-925'
R5500-3/4	3/4	115VAC	8.5	9.0	up to 115'	116-195'	196-290'	291-495'
R5500-1	1	115VAC	9.4	9.9	N/A	up to 175'	176-265'	266-445'

## GENERAL SPECIFICATIONS

MODEL	RAM 100	RAM 1000	RAM 5500 3/4 HP	RAM 5500 1HP
<b>MAX. GATE TRAVEL</b>	20 feet	45 feet	45 feet	45 feet
<b>MAX. GATE WEIGHT</b>	700 lbs	1000 lbs	1500 lbs	2500 lbs
<b>CYCLES</b>	Continuous	Continuous	Continuous	Continuous
<b>CAPACITOR</b>	Aerovox 65µf, 240 V, 50/60 HZ, protected S 1000AFC	Aerovox 65µf, 240 V, 50/60 HZ, protected S 1000AFC	Aerovox 50µf & 65µf, 240 V, 50/60 HZ, protected S 1000AFC	Aerovox 75µf & 75µf, 240 V, 50/60 HZ, protected S 1000AFC
<b>APPLICATION</b>	Residential/ Commercial	Commercial/ Industrial	Commercial/ Industrial	Commercial/ Industrial
<b>FINISH AND CONSTRUCTION</b>	Gold/Zinc plated 3/16" H.R. Metal	Gold/Zinc plated 3/16" H.R. Metal	Gold/Zinc plated 3/16" H.R. Metal	Gold/Zinc plated 3/16" H.R. Metal
<b>CONTINUOUS DUTY MOTOR</b>	1/2 Hp 115 Volts. AC 4.5 amp. 1625 rpm.	1/2 Hp 115 Volts. AC 4.5 amp. 1625 rpm.	3/4 Hp 115 Volts. AC 8.5 amp. 1625 rpm.	1 Hp 115 Volts. AC 9.4 amp. 1625 rpm.
<b>POWER FAILURE RELEASE</b>	Exclusive Foot Pedal Release (RPI-TL only)	Exclusive foot pedal release or optional battery back-up system (BBS or RPI-TL)	Exclusive foot pedal release or optional battery back-up system (*BBS or RPI-TL)	Exclusive foot pedal release or optional battery back-up system (*BBS or RPI-TL)
<b>OVERALL DIMENSIONS</b>	H 22" - L 14½" - W 15"	H 27" - L 16" - W 16½"	H 27" - L 16" - W 16½"	H 27" - L 16" - W 16½"
<b>GATE TRAVEL SPEED</b>	Approx. 1' per sec	Approx. 1' per sec	Approx. 1' per sec	Approx. 1' per sec
<b>SHIPPING WEIGHT</b>	110 lbs	125 lbs	135 lbs	135 lbs

\*BBS is only capable for 1000 lb gates or less.



### WARNING

Do not exceed the specifications. The warranty on your unit will be void if the installation exceeds the recommended specifications.

#### Note:

Model RAM 100 is designed to be installed only for front installations.



**RAM 100**

#### Note:

Model RAM 1000 and RAM 5500 can be used for center and rear installation with gates up to 25' maximum.

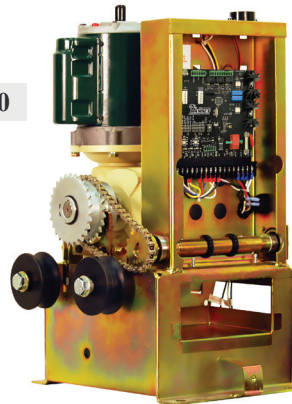

**RAM 1000**

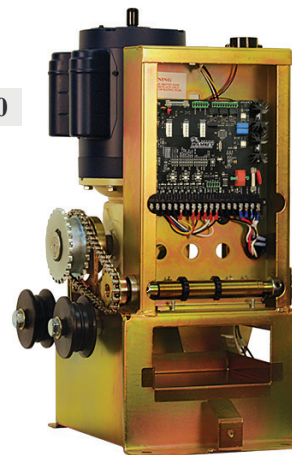

**RAM 5500**

3/4 Hp  
(1Hp not shown)



#### EMERGENCY RELEASE

Exclusive foot pedal release disengages the gate from the motor so it can be opened manually.



# RAM 100 INSTALLATION SPECIFICATIONS

**⚠ WARNING** Do not exceed the specifications. The warranty on your unit will be void if the installation exceeds the recommended specifications.

All Sliding Gate Operators are factory preset for (LH) Left Hand Installations. RAM 100 is for front installation only.

### CONCRETE PAD CONSTRUCTION

Dimensions given for the pad are based on soil bearing shear of 2000 P.S.F. These figures may have to be adjusted depending on local soil conditions.

1. Construct form for mounting pad according to dimensions shown in Figure 1, 2 and 3.
2. Locate mounting pad according to dimensions given in illustration.
3. Level top edge of form.
4. Set reinforcing bars and wire mesh.
5. Mix concrete, pour mixture into form. Level and finish surface after pouring is complete.
6. Allow pad to cure for 48 hours, and remove forms.

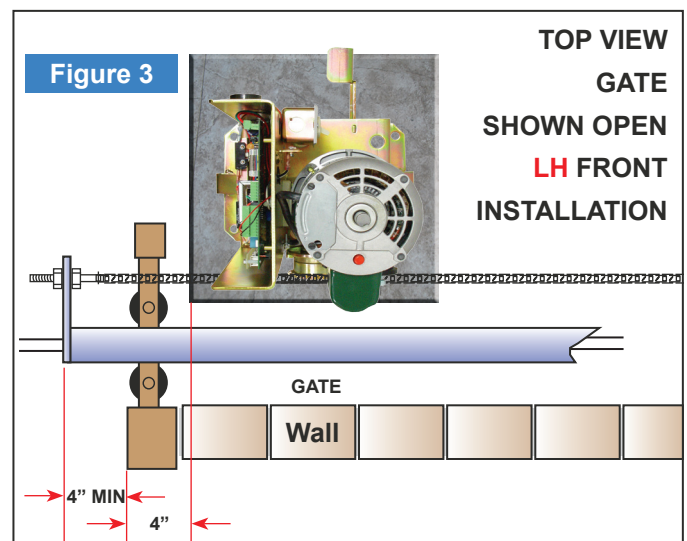
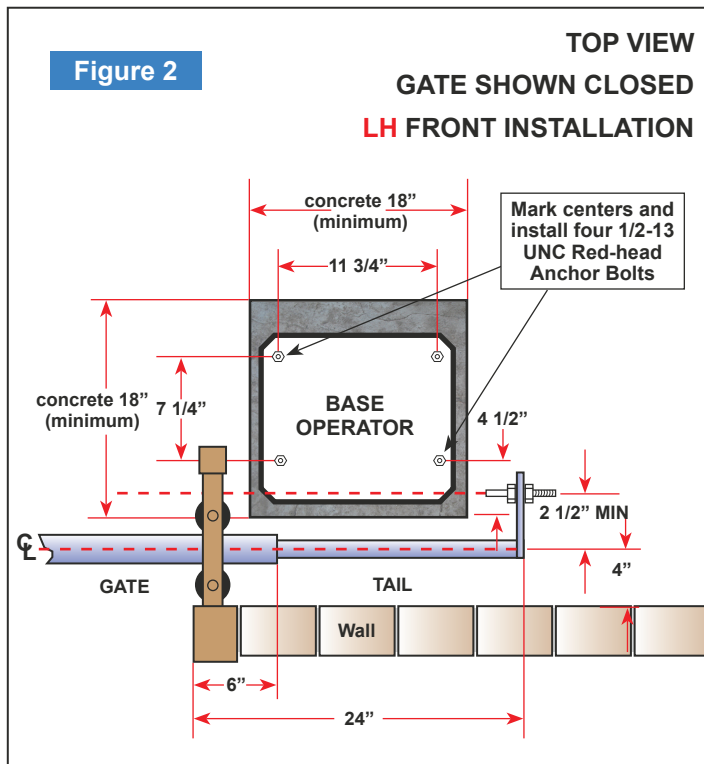
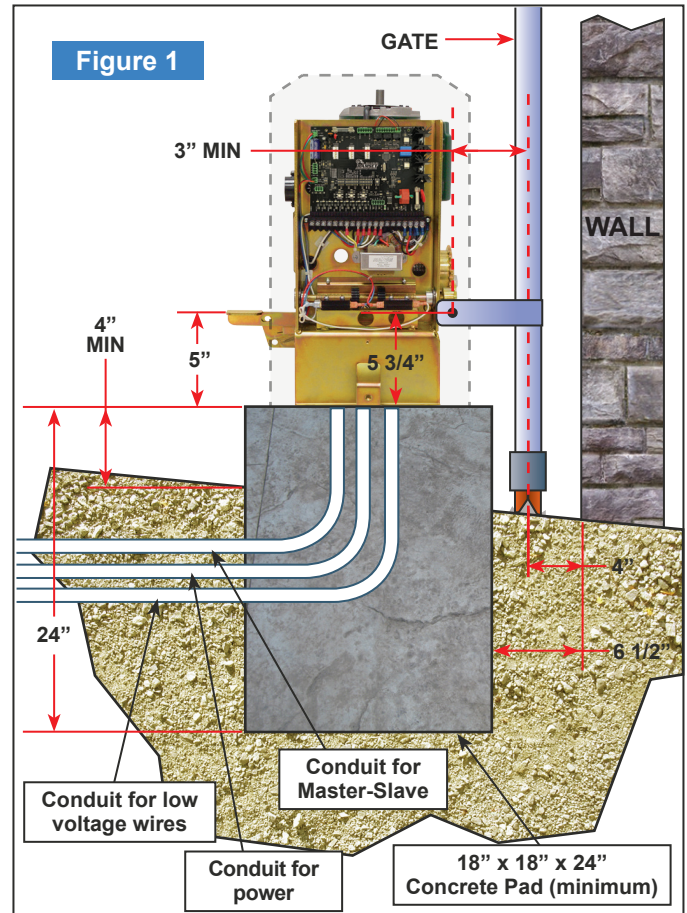

RAM 100 • 1000 • 5500

# RAM 100 FRONT INSTALLATION

RAM 100 IS FOR FRONT INSTALLATION ONLY. FOR CENTER OR REAR INSTALLATIONS A RAM 1000/5500S IS NEEDED.

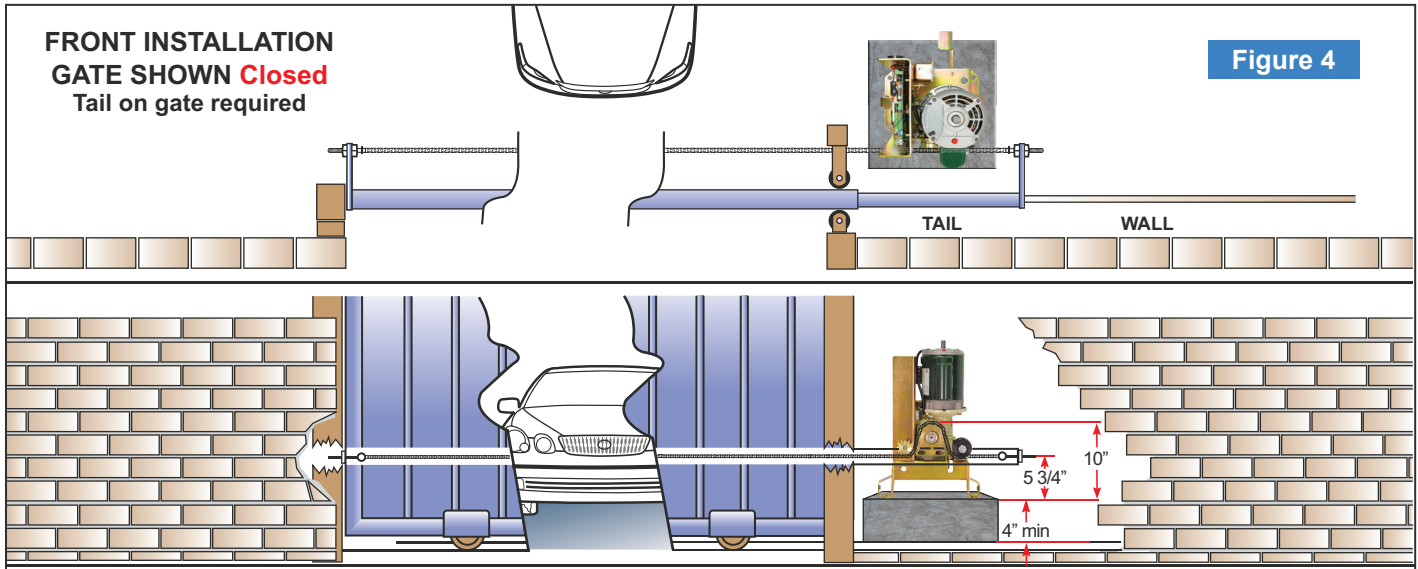

# FOOT PEDAL RELEASE



### WARNING

We do not recommend use of the foot pedal on installations with steep inclines. Always make sure the gate is secured when using the foot pedal to avoid sudden movements from the gate. Make sure to show the end-user proper safety precautions when using the foot pedal.

After proper use of the foot pedal, be sure to lightly kick the pedal towards the right side to spring the pedal up and re-engage your gate.

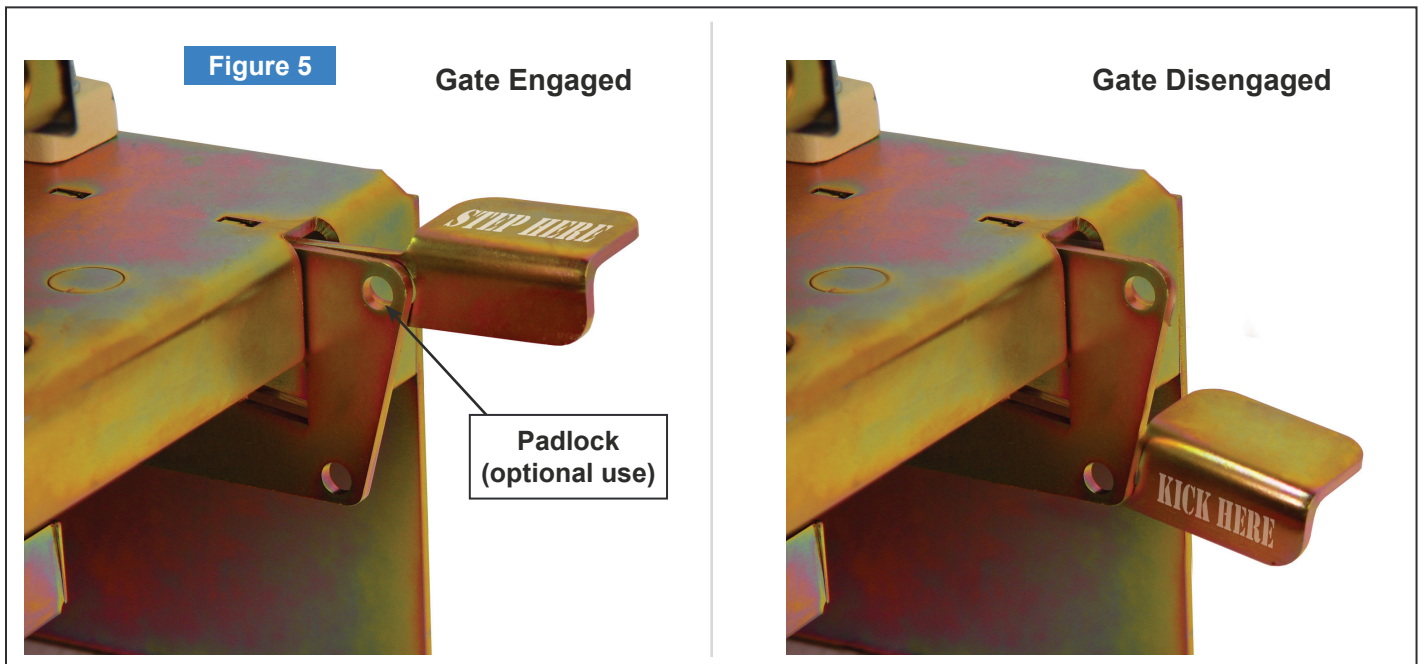

**NOTE:** Your operator will not respond until your gate is properly engaged.



# RAM 1000/ RAM 5500 INSTALLATION SPECIFICATIONS

**! WARNING** Do not exceed the specifications. The warranty on your unit will be void if the installation exceeds the recommended specifications.

*All Sliding Gate Operators are factory preset for (LH) Left Hand Installations.*

### CONCRETE PAD CONSTRUCTION

Dimensions given for the pad are based on soil bearing shear of 2000 P.S.F. These figures may have to be adjusted depending on local soil conditions.

1. Construct form for mounting pad according to dimensions shown in Figure 6, 7 and 8.
2. Locate mounting pad according to dimensions given in illustration.
3. Level top edge of form.
4. Set reinforcing bars and wire mesh.
5. Mix concrete, pour mixture into form. Level and finish surface after pouring is complete.
6. Allow pad to cure for 48 hours, and remove forms.

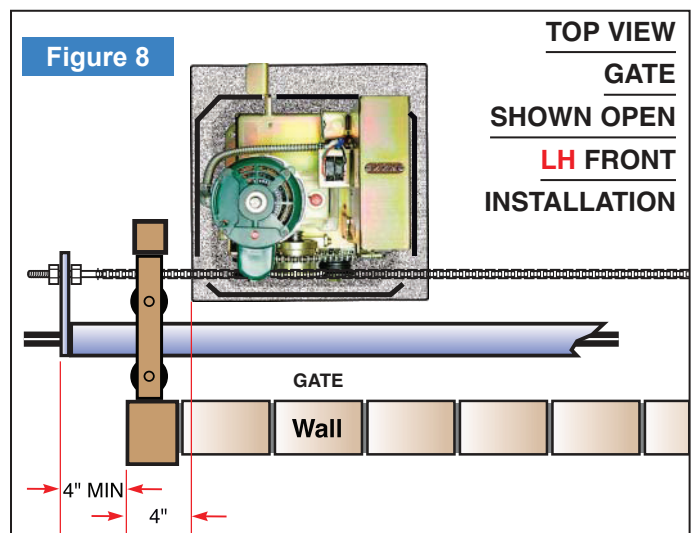
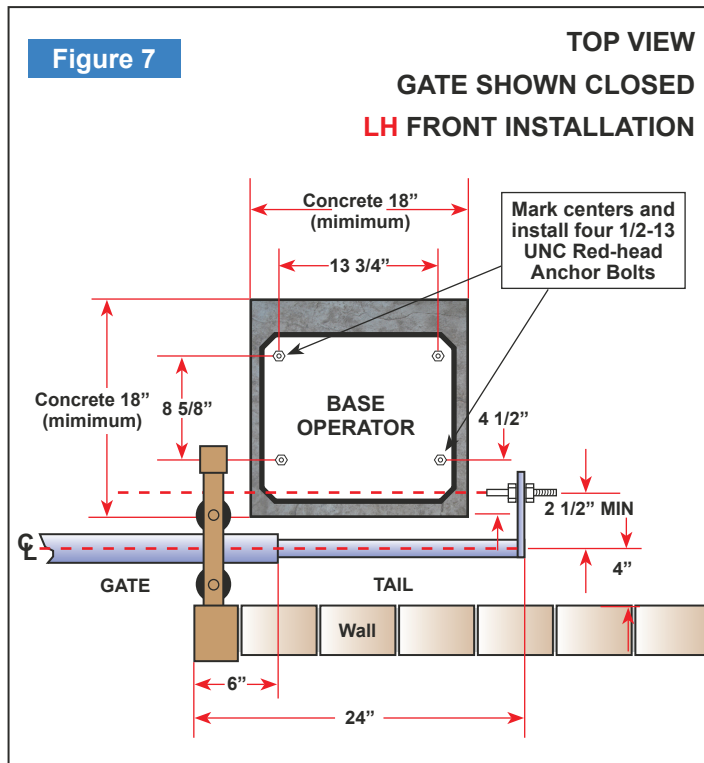
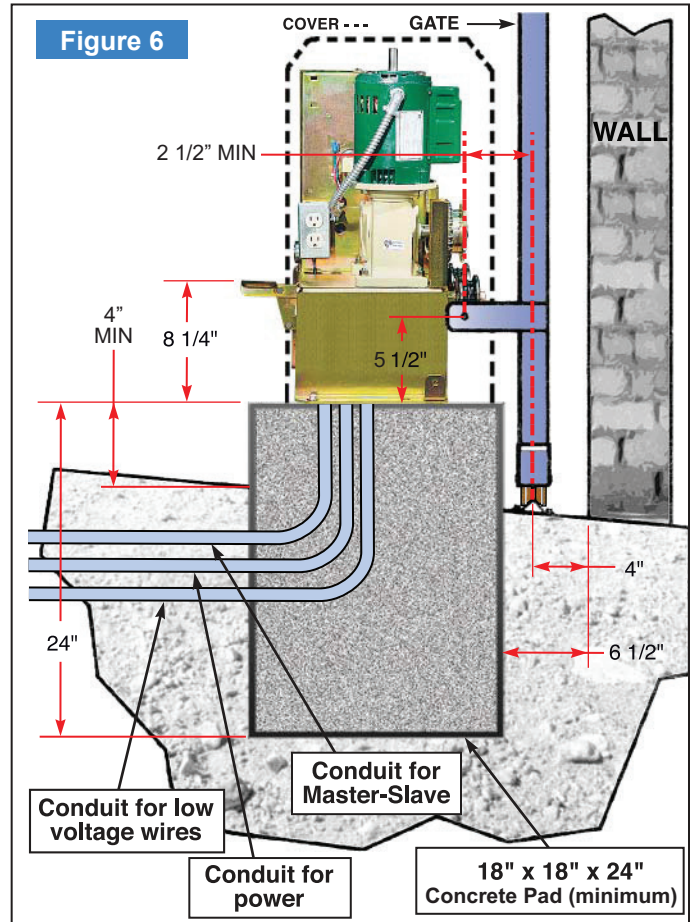

RAM 100 • 1000 • 5500

# RAM 1000/ RAM 5500 TYPES OF INSTALLATIONS

RAM 100 • 1000 • 5500

**FRONT INSTALLATION**  
GATE SHOWN **Closed**  
Tail on gate required

**Figure 9**

Inside Property

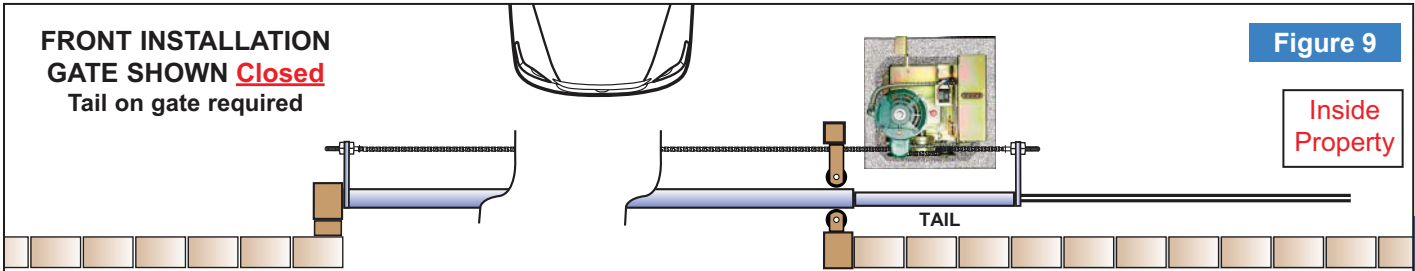

Outside Property

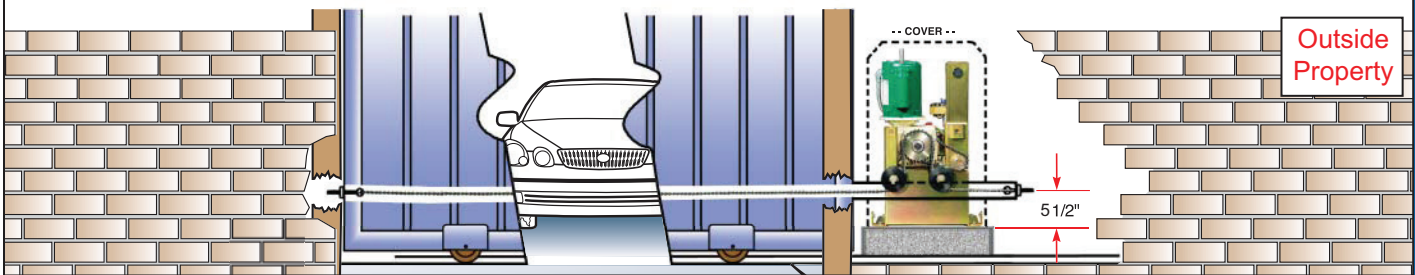

**CENTER INSTALLATION**  
GATE SHOWN **Fully Open**  
No tail on gate required

**Figure 10**

Inside Property

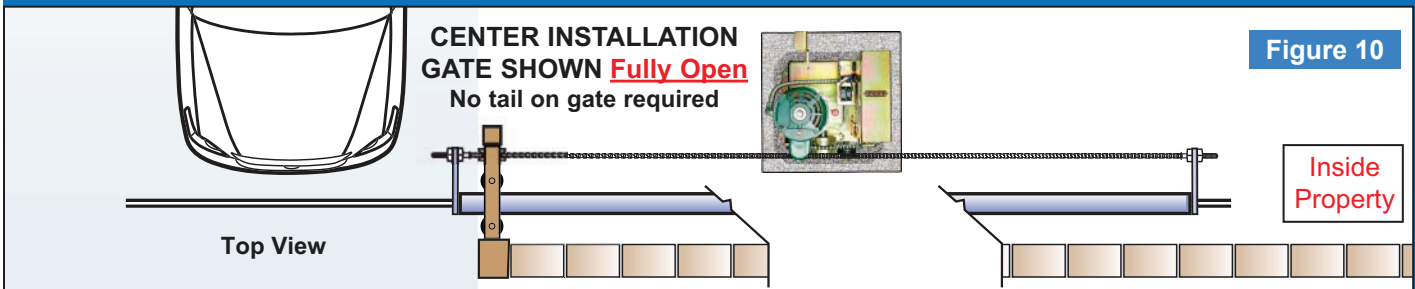

Front View

**WARNING:**  
USE ONLY CHAIN  
GUARDED PULLEYS

Outside Property

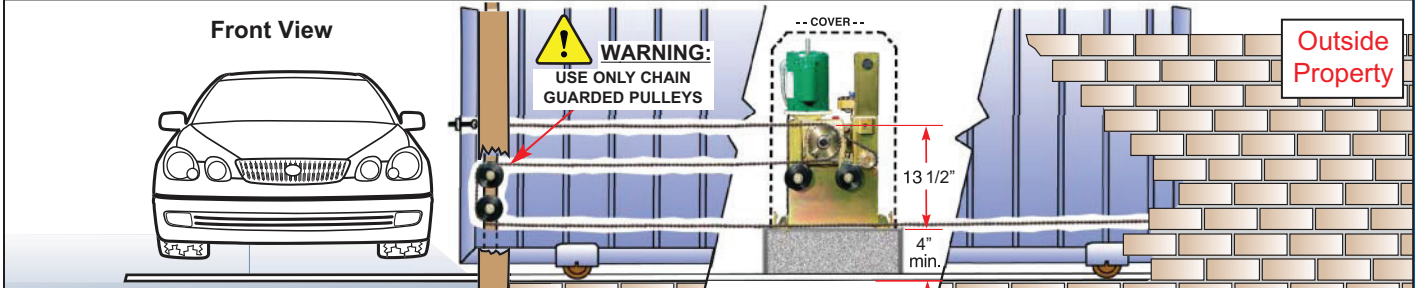

**REAR INSTALLATION GATE SHOWN**  
**Fully Open**  
No tail on gate required

**Figure 11**

Inside Property

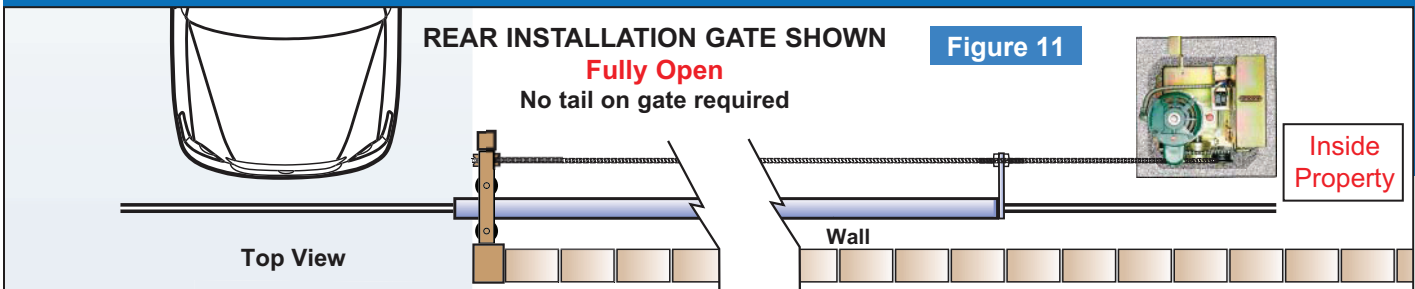

Front View

**WARNING:**  
USE ONLY CHAIN  
GUARDED PULLEYS

Outside Property

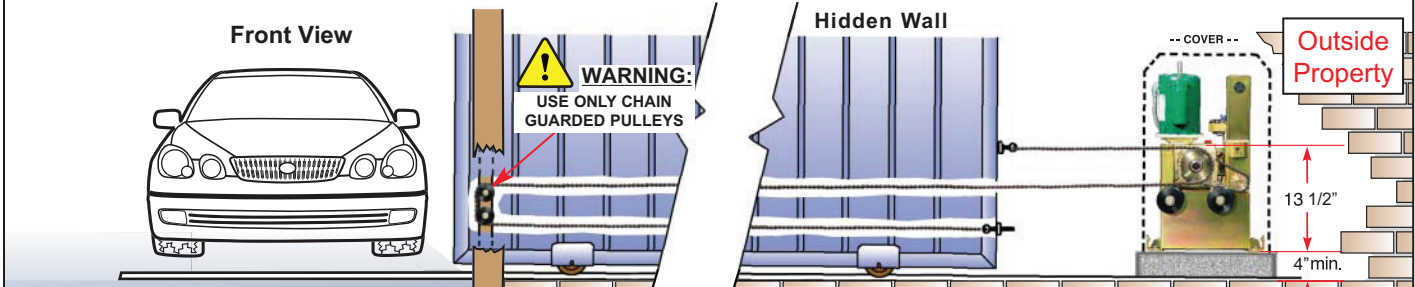



## LOOP SENSOR INSTALLATION

Ramset Gate Operators should always be installed with non-contact sensing devices such as Loop Detectors, Photo Eyes or the equivalent.



A non-contact sensor (photoelectric sensor or equivalent) and a contact sensor (edge device or equivalent) is required on each individual installation to comply with UL325.

**Reversing Loops** on the ground floor, prevents gate from closing when vehicle is in loop area.  
**Exit Loops** on the ground floor, opens gate when vehicle crosses loop area.

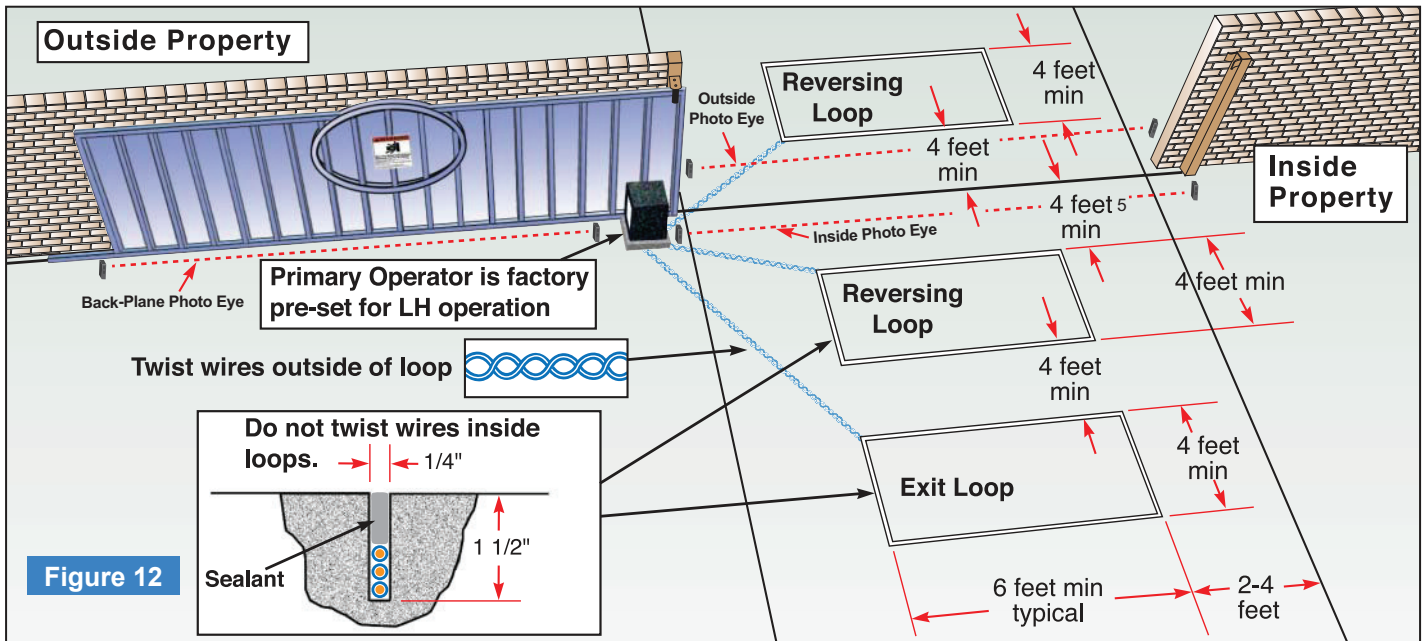

Figure 12

## GATE TRAVEL ADJUSTMENT

**! TURN POWER OFF BEFORE ATTEMPTING ADJUSTMENT !**

To adjust gate travel, depress spring loaded bracket and spin each Adjustment Nut to the required position (Figure 13, 14). L.E.D. must turn on to indicate position open or close when limit switch is activated by limit switch adjustment nut.

### RAM 100

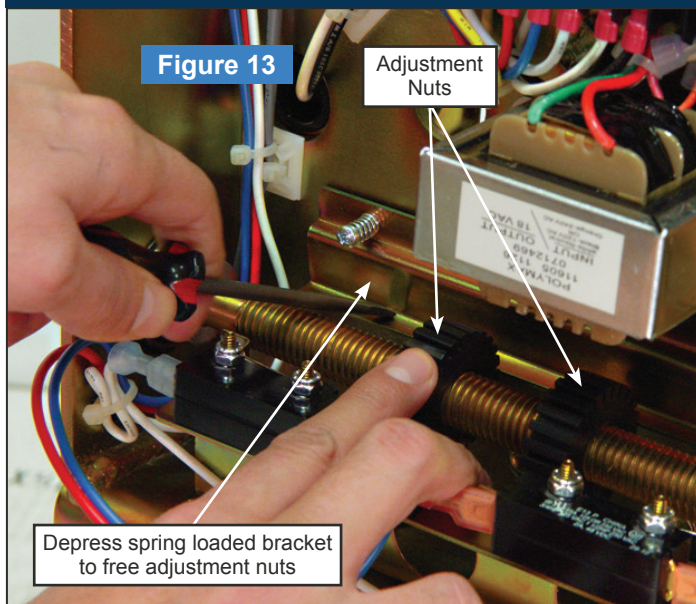

Figure 13

### RAM 1000 / 5500

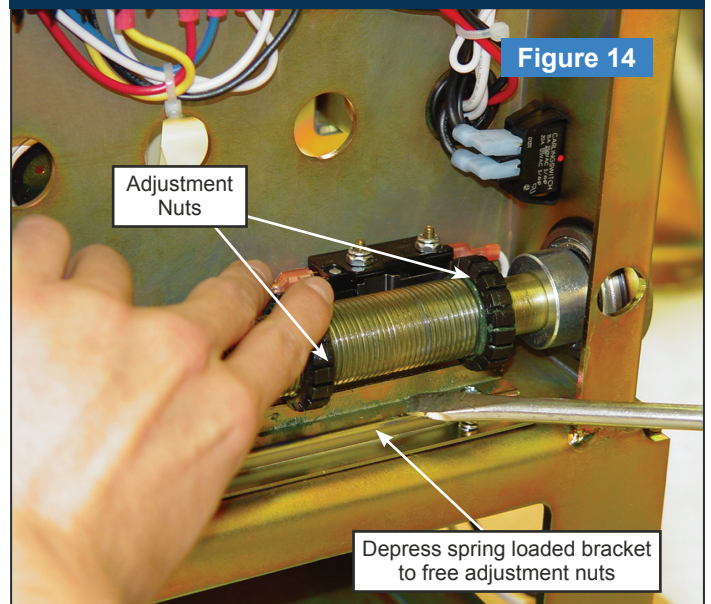

Figure 14

## ENTRAPMENT AND SAFETY PROTECTION

RAM 100 • 1000 • 5500

### WARNING

In order to prevent serious injury, bodily harm or death from a moving gate:

- Entrapment protection devices must be installed to cover any and all entrapment danger areas and locations during a gates opening and closing cycles.

Since every installation is different, it is up to a qualified and trained technician to determine:

- All Possible Entrapment areas & locations
- The amount and type of entrapment protection devices that are needed.

Approved anti-entrapment devices:

- Miller's Edge "PrimeGaurd"
- Miller's Edge "ReflectiGaurd"
- Miller's Edge "Wireless Edge Link"
- Miller's Edge "The Solution"
- EMX "IRB-MON"

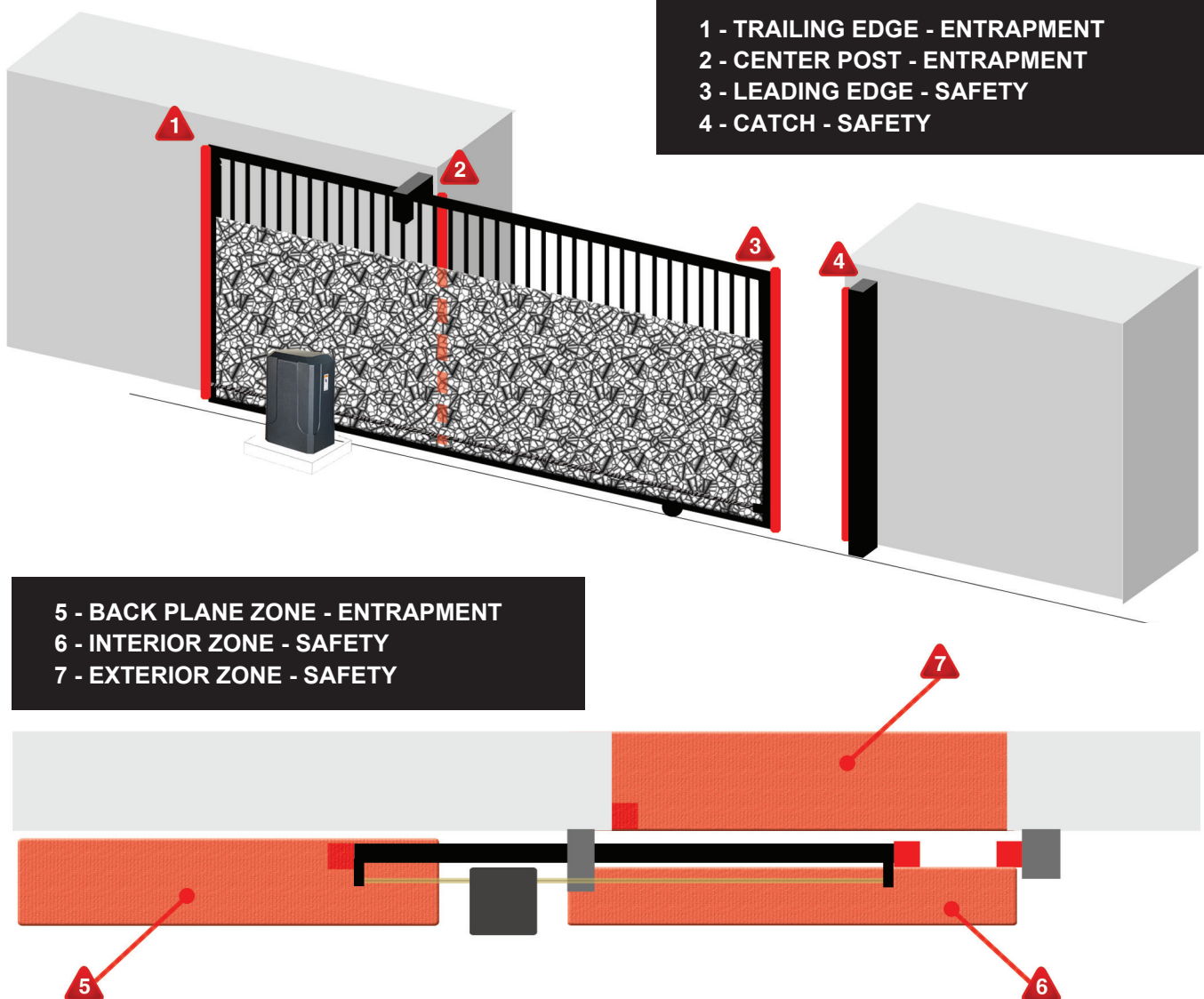

## ENTRAPMENT AND SAFETY PROTECTION

### General entrapment protection provisions

A vehicular gate operator shall have provisions for, or be supplied with, at least two independent entrapment protection means as specified in Table 1. At installation, both entrapment protection devices must be installed.

Table 1

Horizontal slide, vertical lift, and vertical pivot
Entrapment protection types**
A, B1, B2 or D
<p><b>NOTE</b> - The same type of device shall not be utilized for both entrapment protection means. Use of a single device to cover both the opening and closing directions is in accordance with the requirement: however, a single device is not required to cover both directions. A combination of one Type B1 for one direction and one Type B2 for the other direction is the equivalent of one device for the purpose of complying with the requirements of either entrapment protection means.</p> <p><b>**Entrapment protection types:</b></p> <p><b>Type A</b> - Inherent entrapment protection system.  <b>Type B1</b> - Non-contact sensor (photoelectric sensor or the equivalent).  <b>Type B2</b> - Contact sensor (edge device or the equivalent).  <b>Type D</b> - Actuating device requiring continuous pressure to maintain opening or closing motion of the gate.</p>

A gate operator utilizing entrapment protection designated Type B1 in Table 1 by having provision for connection of, or providing with the operator, a non-contact sensor (photoelectric sensor or equivalent) shall, upon sensing an obstruction in the direction of travel of the gate:

- a) Stop or reverse the gate within a maximum of 2 s,
- b) Stop the gate, or stop and initiate reversal of the gate upon sensing a second sequential obstruction.
- c) Result in a gate at rest remaining at rest unless a Type D device is actuated, and
- d) Return to normal operation when the sensor is no longer actuated.

A gate operator installed in accordance with the manufacturer's instructions utilizing external entrapment protection designated Types B1 or B2 in Table 1 by having provision for connection of such device, or providing such device with the operator, shall monitor for the presence and correct operation of the device at least once during each open and close cycle. Should the device not be present, or a fault condition occur that precludes the sensing of an obstruction, including an interruption of the wireless signal to the wireless device or an open or short circuit in the wiring that connects the external entrapment device to the operator and the device's supply source, the operator shall require constant pressure or actuation to initiate and continue movement of the gate in either the opening or closing direction. Upon removal of pressure, movement of the gate shall cease. Unless supplied with separate Open and Close buttons, each subsequent pressing of the control button shall reverse direction of the gate.



# INTELLIGATE LED LAYOUT

RAM 100 • 1000 • 5500

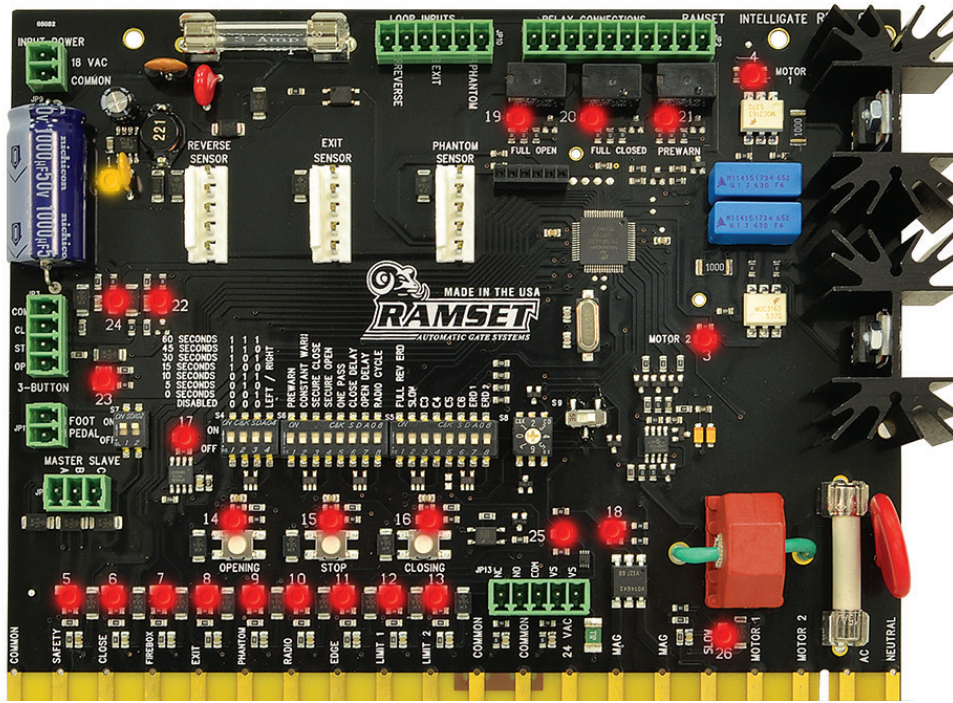

LED #	FUNCTION	STATUS	RESULTS	TROUBLESHOOT
1	Power	ON	18-24V AC/DC Present	Check 115VAC, Check 3A Fuse, Check Transformer
		OFF	No input power	
3-4	Motor 1 & 2	ON	Motor is running	Check 15A SB fuse, Check 115V AC, check motor over-load button (red)
		OFF	Motor is stopped	
5-11	Accessories (Safety, Close, Firebox, Exit, Phantom, Radio, Edge)	ON	Triggered by Accessory	Disconnect the accessories, if LED goes 'off' then accessory is bad or not properly aligned
		OFF	Normal status	
12-13	Limit 1 & 2	ON	Gate is on a limit	Check limit switch & wiring
		OFF	Gate is in between limits	
14-16	Opening, Stop, Closing	ON	One of these LEDs is always 'on'. Gate is either opening, closing or stopped.	If LEDs 14, 15 & 16 are all OFF, then the control board needs to be repaired/replaced.
		OFF	---	
17	Communication	ON	Blinks when processing signals	If LED is always 'on' or never 'on' then control board needs to be repaired/replaced.
		OFF	---	
18	Mag Lock	ON	Energizes mag lock when closing or closed.	If not energizing when lit, check mag lock transformer, voltage on mag lock & mag lock
		OFF	De-energized when gate is opening or opened.	
19-20	Full Open, Full Closed	ON	Gate is on a limit	Check dip switch A4, make sure the chain was connected in the right position
		OFF	Gate is inbetween limits	
21	Pre Warn & Constant Warn	ON	Relay for pre warn or constant warn is active	Make sure dip switch B1 or B2 is 'on'. Make sure an alarm/light has been added to the relay connections plug
		OFF	Pre warn & active warn is not active	
22	3-Button Stop or Foot Pedal Switch	ON	Either the 3-button stop or foot pedal switch is being triggered	Check foot pedal switch & stop button on JP3 & JP11. Check S7 configuration.
		OFF	Normal status	
23-24	3-Button Open, 3-Button Close	ON	3-button is triggering the open or close	Check the 3-button station or anything connected to JP3.
		OFF	Normal status	
25	Monitored Anti-Entrapment Device	ON	Anti-entrapment device is being triggered or disconnected	Make sure all 5 wires are correctly connected to JP13. Make sure the anti-entrapment device is working and aligned.
		OFF	normal status	
26	Slow Down	ON	Gate is in slow start/stop mode	Check dip switch C2.
		OFF	Slow down mode is turned off	



# PUSHBUTTON CONTROLS

Three pushbuttons are located under the dip switches for operation of the gate (see Figure 15). The opening, stop and closing buttons can be utilized to set limit switches and verify proper system operation when installing or servicing an operator.

**Opening**  
Opens the gate.

**Stop**  
Stops the gate.

**Closing**  
Closes the Gate.

**RESETTING THE E.R.D. (Electronic Reversing Device)**

With power 'on' push all three pushbuttons for approximately 5 seconds. All three LEDs should blink. Once they start blinking, let go of the three pushbuttons.

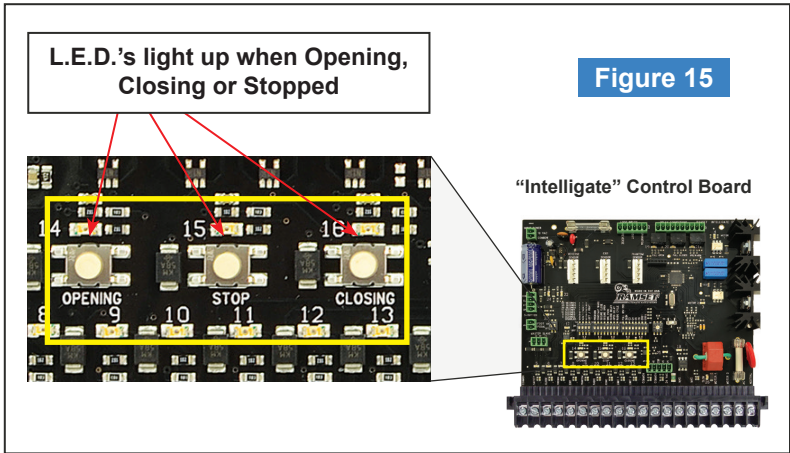



**WARNING**

When pushing the three buttons, the gate can move at any time. Always keep body parts and clothing clear of pulleys, sprockets and all moving and electrical components in the operator to help prevent serious injury.

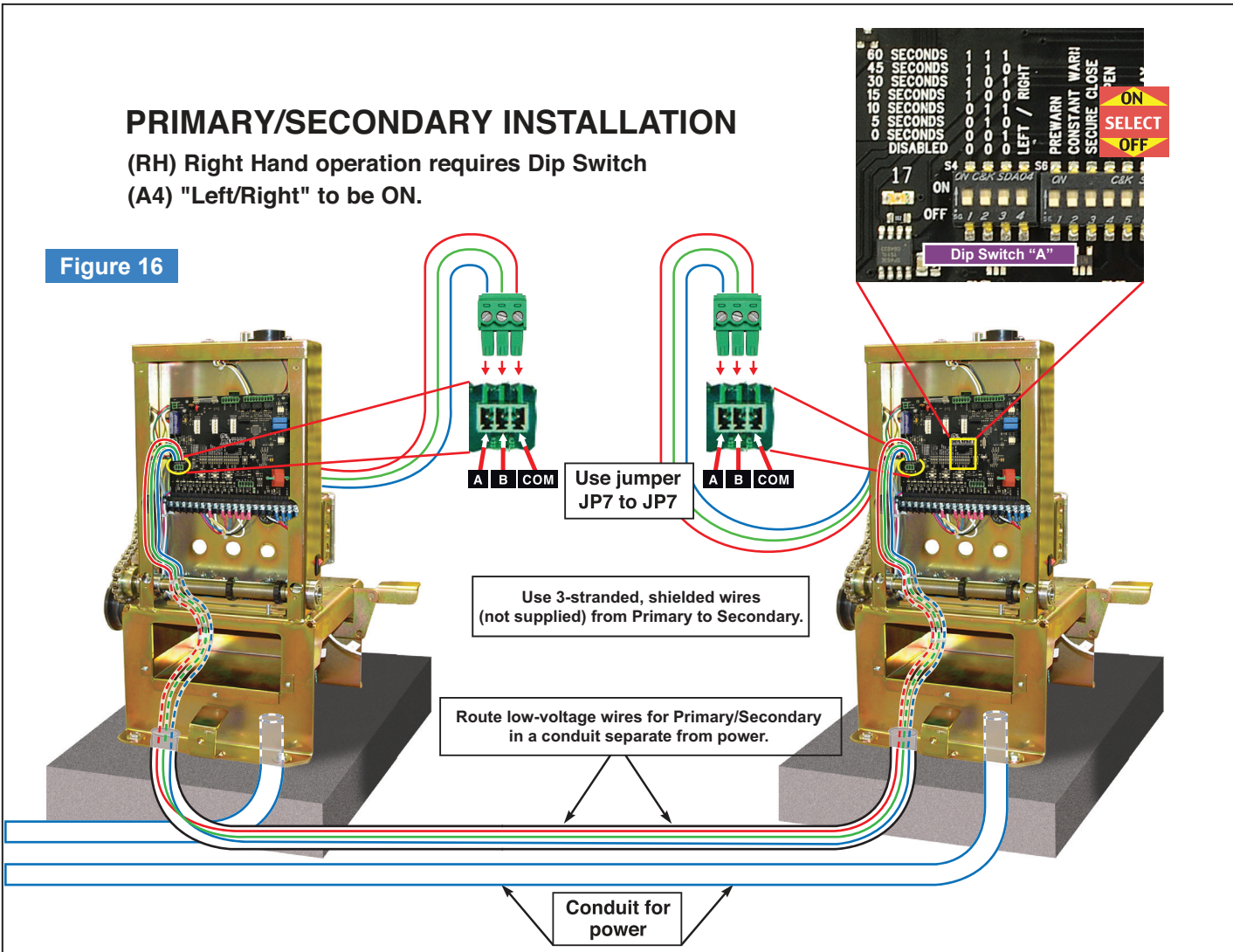

RAM 100 • 1000 • 5500

# DIP SWITCH CONFIGURATION

Figure 17

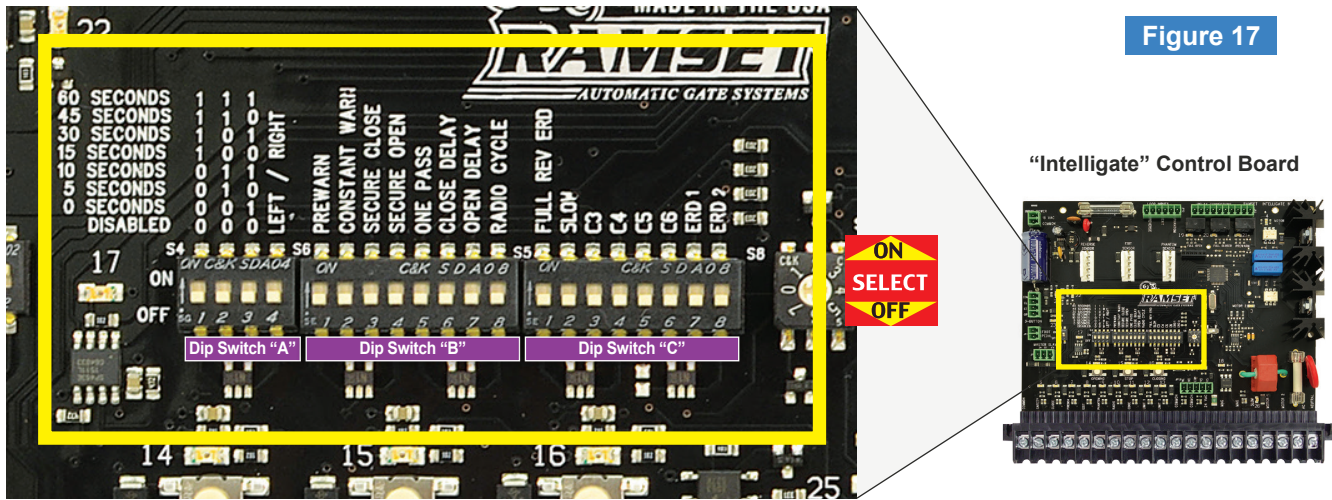

## DIP SWITCH S4 - "A"

DIP SWITCH "A" 1, 2 & 3; AUTOMATIC TIMER TO CLOSE GATE				
'0' is "OFF"	'1' is "ON"			
Switch	1	2	3	Gate Open Duration:
	0	0	0	Disabled
	0	0	1	00 Seconds
	0	1	0	5 seconds
	0	1	1	10 seconds
	1	0	0	15 seconds
	1	0	1	30 seconds
	1	1	0	45 seconds
	1	1	1	60 Seconds

## DIP SWITCH "A" 4 - LEFT/RIGHT

OFF	Left-hand installation
ON	Right-hand installation. Reverses the motor and limit wires without moving any wires.

## DIP SWITCH S6 - "B"

### B1 - PREWARN

OFF	Normal operation
ON	Triggers the relay on JP2, pins 7 & 8, for 3 seconds before the gate moves in any direction.

### B2 - CONSTANT WARN

OFF	Normal operation
ON	Triggers the relay on JP2, pins 7 & 8

### B3 - SECURE CLOSE

OFF	Normal operation
ON	When power is lost and then regained, if all devices are clear and it's safe, the gate will close.

### B4 - SECURE OPEN

OFF	Normal operation
ON	If the gate comes off of the limit without a valid command, the gate will re-open.

### B5 - ONE PASS

OFF	Normal operation
ON	While the gate is opening, if the safety input is triggered and then cleared, the gate will immediately start closing. If the safety input is then activated again, before the gate is fully closed, the gate will stop and stay at rest until the safety loop is cleared. At any time if a valid open signal is received, the gate will open.

### B6 - CLOSE DELAY

OFF	Normal operation
ON	Adds a 1 second delay before the gate closes.

### B7 - OPEN DELAY

OFF	Normal operation
ON	Adds a 1 second delay before the gate opens.

### B8 - RADIO CYCLE

OFF	Gate will open, if on the close limit, and close, if on the open limit. If in travel, the gate will always open or continue to open.
ON	Gate will open, if on the close limit, and close, if on the open limit. If in travel, the gate will stop with the first command and then reverse with a second command.



# DIP SWITCH CONFIGURATION

## DIP SWITCH S5 "C"

C1 - FULL REV ERD	
OFF	Normal operation
ON	When closing, if the gate senses an obstruction (ERD), the gate will stop and reverse all the way to the fully open limit.



C2 - SLOW	
OFF	Normal operation
ON	Adds a slow start when the gate opens and a slow stop when the gate closes. The slow stop is triggered by the slow stop switch. (ONLY ON THE ALL SECURE RAIL DRIVE OPERATOR)

## ROTARY SWITCH S8

Manual ERD adjustments	
Range 0 to 7	
0	Most Sensitive
7	Least Sensitive

C3, C4, C5 & C6	
OFF	No function. These 4 switches should not be turned to the 'on' position.

## SLIDE SWITCH S9

Switches from automatic ERD adjustment (Dip switch C7 & C8) and Manual ERD adjustment (Rotary switch S8)	
Left	Automatic ERD (Dip C7 & C8)
Right	Manual ERD (Rotary S8)

C7 & C8 - ERD 1 & ERD 2			
Switch	7	8	Sensitivity
	OFF	OFF	Most Sensitive
	OFF	ON	Medium Sensitivity
	ON	OFF	Low Sensitivity
	ON	ON	Least Sensitivity

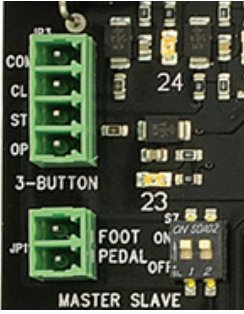

## DIP SWITCH S7

Eliminates having to jumper the foot pedal plug (JP11) and the stop input (JP3).

1 - Foot pedal plug bypass	
ON	Bypass Mode
OFF	Active Mode
1 - Stop input plug bypass	
ON	Bypass Mode
OFF	Active Mode

**⚠ WARNING:**  
Do not bypass the foot pedal plug on any unit that has a foot pedal. Bypassing the foot pedal plug can cause damage to you operator, voids all warranties, and may cause serious injury.

RAM 100 • 1000 • 5500

# TERMINAL STRIP CONNECTIONS

Figure 18

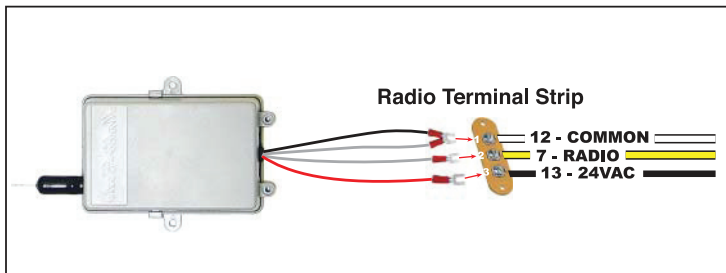
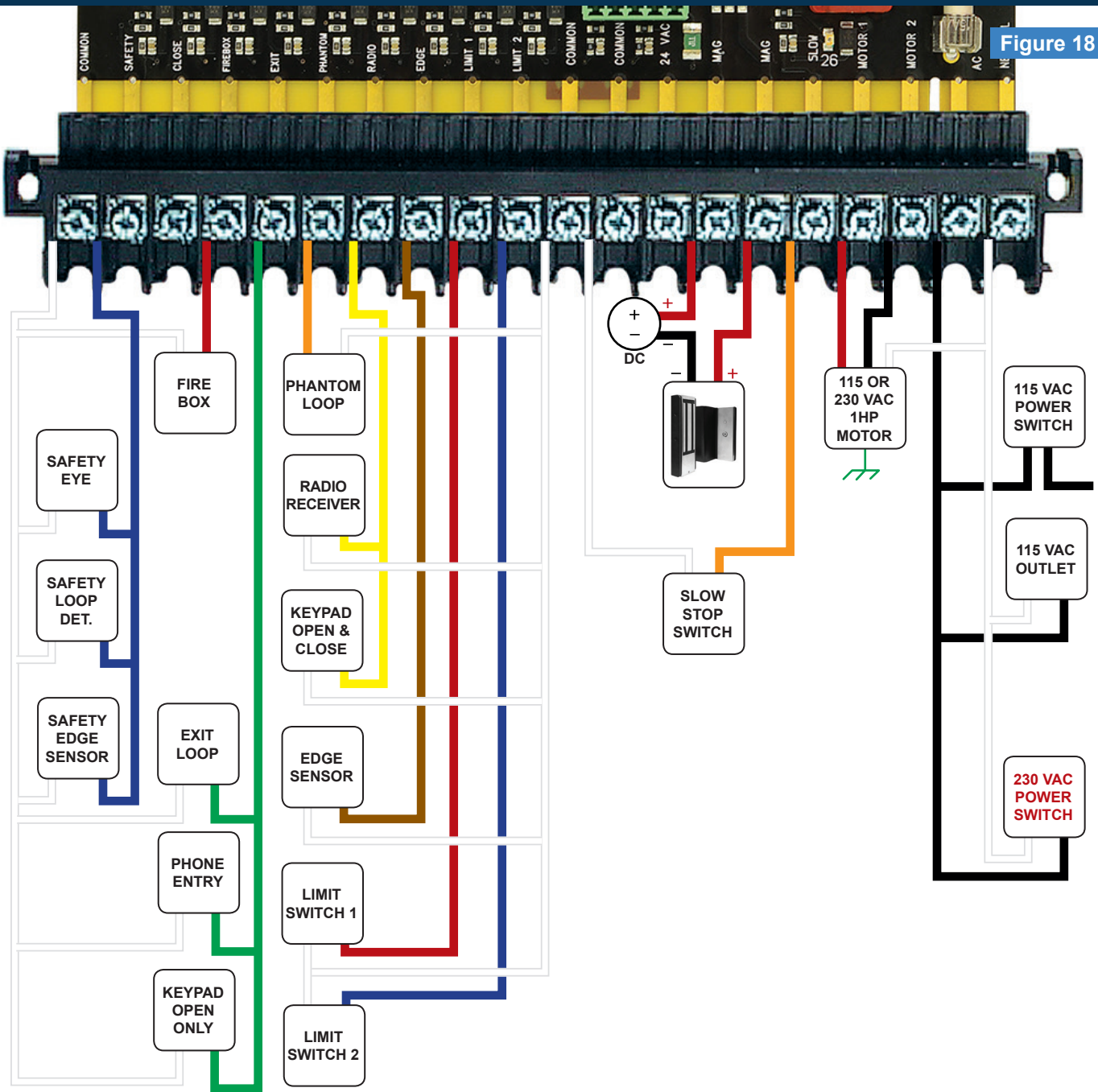

## TERMINAL STRIP CONNECTIONS

### Terminal # 1 - COMMON

Low voltage common.

### TERMINAL 2 - SAFETY

Stops the gate from closing.

- GATE OPEN - Holds gate open.
- GATE CLOSED - Gate stays closed.
- GATE OPENING - Gate continues to open.
- GATE CLOSING - Gate stops, then opens.

The function can be altered with Dip Switch B5 (see dip switch configuration). Used with loop detectors, photo eyes, safety edges...etc. Becomes active with a closed contact to common.

### Terminal # 3 - CLOSE

Closes the gate.

Used with 3-button stations or pushbuttons. Becomes active with a closed contact to common.

### Terminal # 4 - FIREBOX

Opens the gate with a maintained signal. Used with fire dept. key switches & controls. Becomes active with a closed contact to common. Closes immediately after the closed contact to common is removed.

### Terminal # 5 - EXIT

Opens the gate.

Uses with exit loop detectors, phone entry systems, keypads, 3-button stations...etc. Becomes active with a closed contact to common.

### Terminal # 6 - PHANTOM

Holds the gate open when the open limit switch is active.

Covers the area of a swing gate's path. Used with loop detectors and photo eyes. Becomes active with a closed contact to common.

### Terminal # 7 - RADIO

Opens, closes and/or stops the gate. Operation depends on dip switch B8 & A1-3 (see dip switch configuration). Used with an RF receiver, pushbutton, keypad... etc. Becomes active with a closed contact to common.

### Terminal # 8 - EDGE

When triggered the gate will stop and remain stopped until the detector is cleared. Once the detector is cleared, the operator will resume normal operation. If triggered twice during one travel, the control board will lock up and the alarm will sound for 6 minutes. After 6 minutes the unit will return to normal operation. Becomes active with a closed contact to common.

### Terminal # 9 and 10 - LIMIT 1 & LIMIT 2

Stops the gate in either the fully open or fully closed position.

Direction depends on dip switch A4 (see dip switch configuration).

Factory wired and should not be moved.

Becomes active with a closed contact to common.

### Terminal # 11 and 12 - COMMON

Low voltage common.

### Terminal # 13 - 24 VAC

Provides 24 VAC for peripheral accessories.

### Terminal # 14 and 15 - MAG1 & MAG2

Provides a closed contact when the gate is closing or closed (like a switch).

Used with a Magnetic Lock.

Needed: A power supply that is rated for the magnetic lock that is being connected. Make sure the power supply is the right voltage and current rating. See wiring diagram on previous page.

### TERMINAL 16 - SLOW

Only available on the All Secure rail drive operator.

Creates a slow stop using the slow stop switch mounted in the operator.

Factory wired and should not be moved.

### Terminal # 17 and 18 - MOTOR 1 & MOTOR 2

Factory wired and should not be moved.

Supplies voltage to the motor.

Direction depends on dip switch A4 (see dip switch configuration).

### Terminal # 19 and 20 - AC HOT & NEUTRAL

115 VAC AND 230 VAC to power the operator. Factory wired and should not be moved.



# PLUG CONNECTIONS

RAM 100 • 1000 • 5500

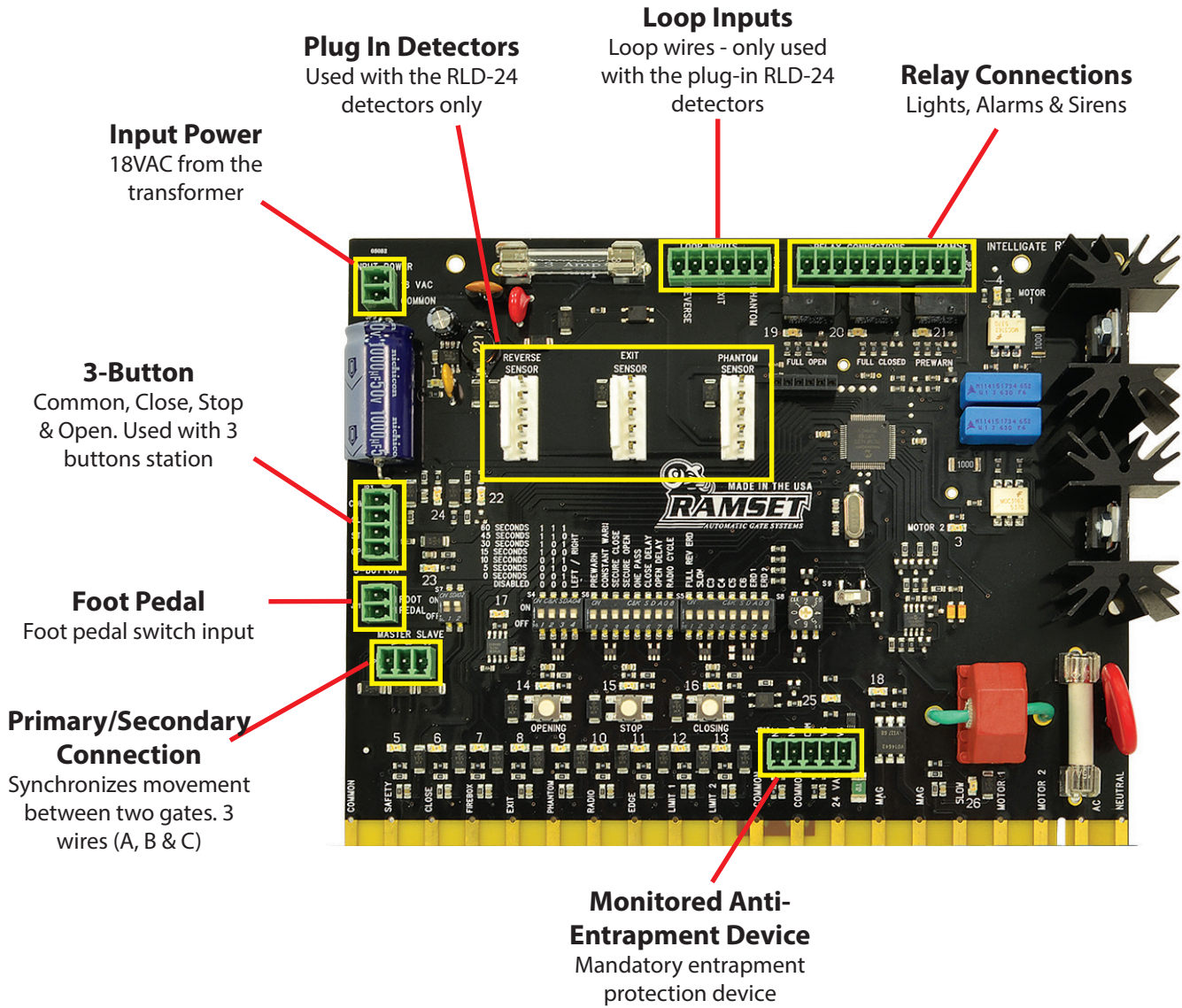

**APPROVED ANTI-ENTRAPMENT DEVICES:**

- MILLER'S EDGE "PRIMEGAURD"
- MILLER'S EDGE "REFLECTIGAURD"
- MILLER'S EDGE "WIRELESS EDGE LINK"
- MILLER'S EDGE "THE SOLUTION"
- EMX "IRB-MON"

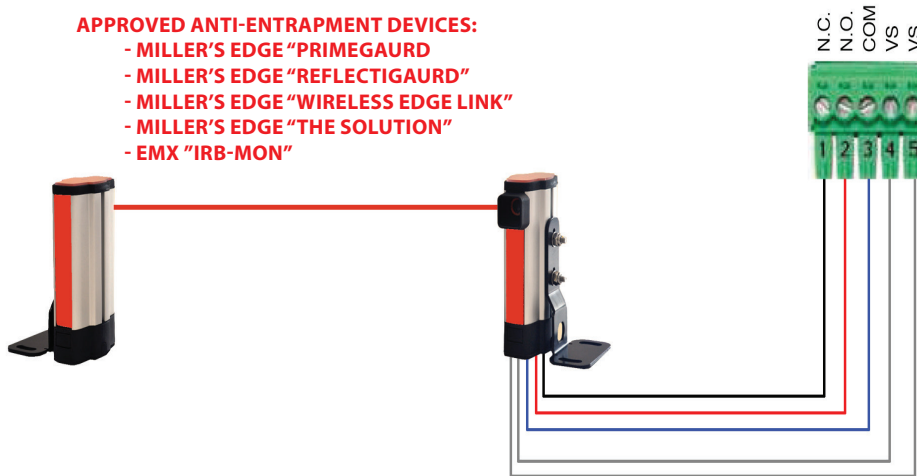

**WARNING**

Never try to bypass or tamper with an anti-entrapment safety device. This may result in serious injury.



## PLUG CONNECTIONS

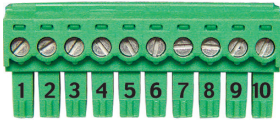

### JP2 - Relay Connections:

- |                      |                                   |
|----------------------|-----------------------------------|
| 1) 24 VDC.           | 5) Relay Common                   |
| 2) 24 VAC            | 6) Fully Closed-N.C.              |
| 3) Do Not Use        | 7-8) Constant Warn/Prewarn - N.O. |
| 4) Fully Open - N.O. | 9-10) ERD Alarm (factory wired)   |

All Relays are rated at 125VAC, 1A.

Used with:

- Lights or Sirens that show the gate is open.
- Constant Warn/Prewarn lights or sirens.
- Alarm that sounds when an obstruction is sensed twice in a single travel.

See "WIRING DIAGRAMS"



### JP3 - 3 Button:

- 1) OP (open) - Normally open connection
- 2) ST (stop) - Normally closed connection
- 3) CL (close) - Normally open connection
- 4) COM - (common)

Used with:

- A 3-button station.
- An anti-entrapment device where the gate should stop and remained stopped.

To use the ST (stop) function, S7 - #1 must be in the 'OFF' position.



### JP7 - Primary/Secondary:

- 1) A
- 2) B
- 3) C

Synchronizes the operation between two gates. Three wire, shielded cable needed.

Align A to A, B to B & C to C from the

primary unit to the secondary unit.



### JP9 - Input Power:

- 1) Common
- 2) 18 VAC

Connection from external transformer to power Control Board.

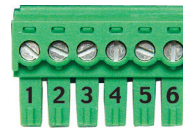

### JP10 - Loop Inputs:

- 1 & 2) Reverse loop wires
- 3 & 4) Exit loop wires
- 5 & 6) Phantom loop wires

Only used with the Ramset

RLD-24 & ILD-24s plug-in loop detectors.



### JP11 - Foot Pedal Plug:

- 1) Common (Foot pedal switch)
- 2) Normally Open (Foot pedal switch)

Only used on models with a foot pedal (RAM 100, 1000, 5500, 300)

On the above mentioned operators, S7 must be in the 'OFF' position

On all other models, S7 must be in the 'ON' position  
Factory wired to the foot pedal switch.



### JP 13 - Monitored Anti-Entrapment Device:

- 1) N.C. (Normally Closed)
- 2) N.O. (Normally Opened)
- 3) Common

- 4) VS (Voltage Supply)
- 5) VS (Voltage Supply)

**\*\*Every installation must have Monitored Entrapment Protection.**

**Without it the operator will not function.**

**APPROVED ANTI-ENTRAPMENT DEVICES:**

- Miller's Edge "PrimeGaurd"
- Miller's Edge "ReflectiGaurd"
- Miller's Edge "Wireless Edge Link"
- Miller's Edge "The Solution"
- EMX "IRB-MON"

## WIRING DIAGRAMS

### Gate Open Light/Siren:

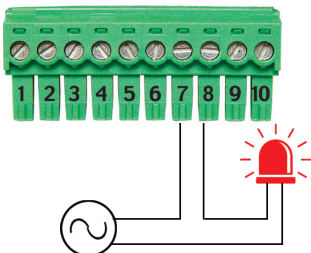

- 1) Wire from JP2-7 to Power supply (+)
  - 2) Wire from JP2-8 to light/siren (+)
  - 3) Wire from power supply (-) to light/siren (-)
- \* **24VAC, 1A max current draw.**

### Constant Warn or Prewarn:

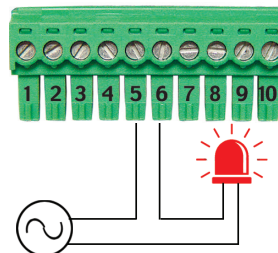

- 1) Wire from JP2-5 to Power supply (+)
  - 2) Wire from JP2-6 to light/siren (+)
  - 3) Wire from power supply (-) to light/siren (-)
- \* **24VAC, 1A max current draw.**

# PARTS DIAGRAM

## RAM 100

RAM 100 • 1000 • 5500

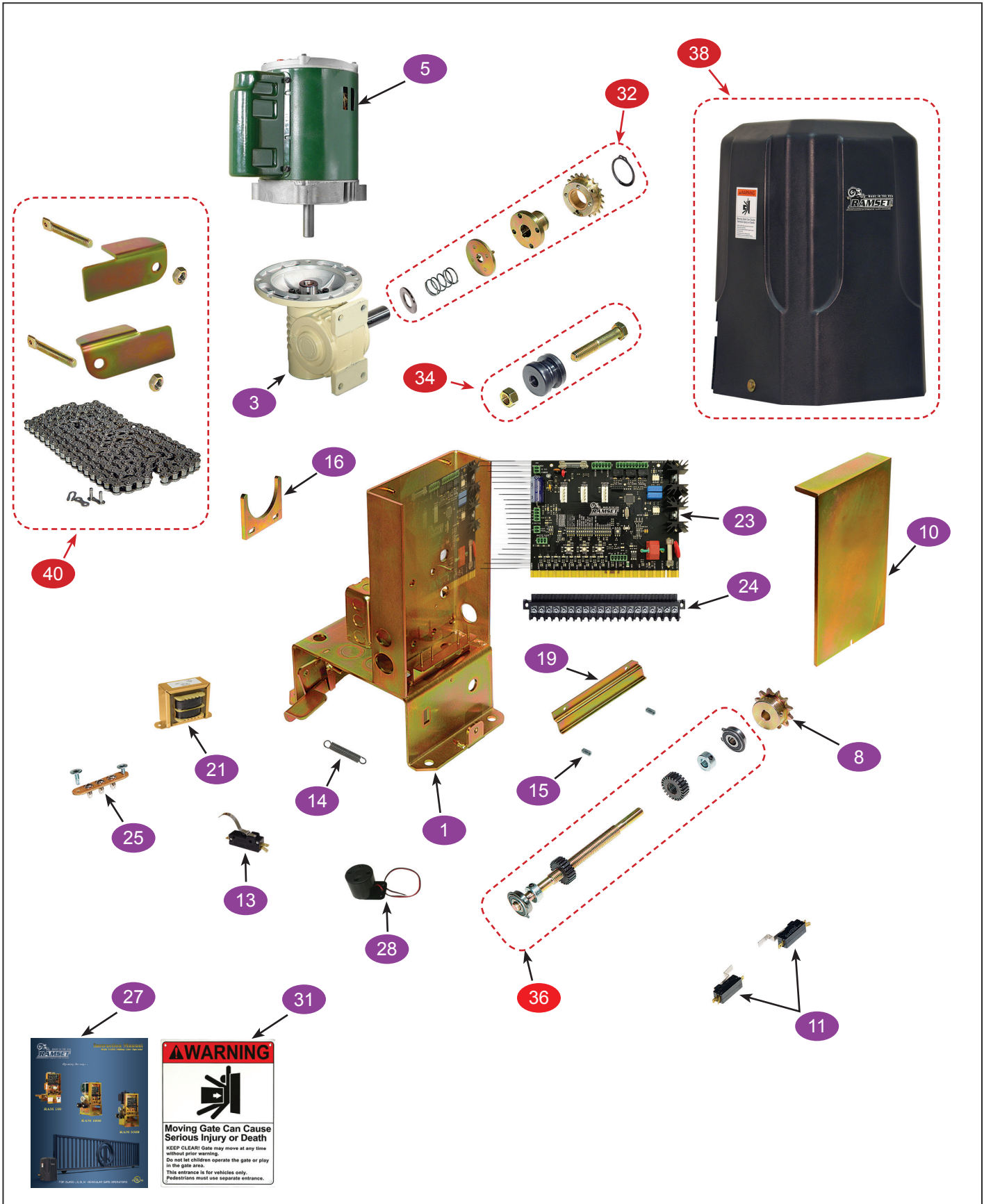

# PARTS DIAGRAM

## RAM 1000 • RAM 5500

RAM 100 • 1000 • 5500





## BILL OF MATERIALS

RAM 100 • 1000 • 5500

ITEM	PART #	PART DESCRIPTION	RAM 100	RAM 1000	RAM 5500-3/4	RAM 5500-1
1	800-00-00	Chassis - R100	1			
2	800-00-01	Chassis - R1000/R5500s		1	1	1
3	800-02-03	Gear Reducer - Size 43, Ratio 30:1 (C-Face)	1			
4	800-02-06	Gear Reducer - Size 60, Ratio 30:1 (C-Face)		1	1	1
5	800-04-00	Motor, C-Face - 120 VAC 1/2 HP	1	1		
6	800-04-01	Motor, C-Face - 120 VAC 3/4HP			1	
7	800-04-02	Motor, C-Face - 120 VAC 1Hp				1
8	800-06-08	Sprocket - 41B12 x 1/2"	1			
9	800-06-09	Sprocket - 41B15 x 3/4"		1	1	1
10	800-14-20	Cover, Metal Control Board	1			
11	800-20-00	Limit Switch - R100	2			
12	800-20-01	Limit Switch - R1000/R5500s		2	2	2
13	800-20-20	Switch, Foot Pedal - R100/R1000/R5500s	1	1	1	1
14	800-22-02	Spring - 1/2" x 2"	1	1	1	1
15	800-22-04	Spring - 1/4" x 1/2"	2	2	2	2
16	800-24-20	Fork, Pedal Release - 3 3/4" x 2 3/4"	1			
17	800-24-21	Pedal Release Fork - 3 7/8" x 2 13/16"		1	1	1
18	800-52-21	Chain, Limit - #41 x 22" (22 Links)		1	1	1
19	800-54-75	Bracket, Spring Loaded - 6 1/2" x 1 1/4"	1			
20	800-54-76	Bracket, Spring Loaded - 6 3/4" x 7/8"		1	1	1
21	800-60-01	Transformer, 115/230VAC TO 20VAC - 20VA (1A)	1	1	1	1
22	800-60-10	Switch, Rocker		1	1	1
23	800-63-00	Control Board - Intelligate - Domestic UL	1	1	1	1
24	800-64-00	Edge Connector - 20 Pin	1	1	1	1
25	800-64-50	Radio Receiver Terminal	1	1	1	1
26	800-66-00	Lexan Control Board Cover- 9 1/4" x 15 1/4"		1	1	1
27	800-68-01	Instruction Manual - R100/R1000/R5500s	1	1	1	1
28	800-70-21	Horn Alarm Buzzer - 120dB	1	1	1	1
29	800-70-52	Plate, Bearing - 2 1/4" x 2 3/8"		1	1	1
30	800-70-75	Shelf, Accessories		1	1	1
31	800-70-98	Warning Sign For Gates - Slide/Swing	2	2	2	2
<b>32</b>	<b>800-75-20</b>	<b>CLUTCH RELEASE ASSEMBLY - R100</b>	<b>1</b>			
	800-06-11	Sprocket, Clutch Release - 41B21H - R100	1			
	800-22-00	Spring - 1 1/4" x 1 1/4" (6 turns)	1			
	800-24-00	4-Pin Disc - R100	1			
	800-40-55	Washer, Flat - ID 1 1/16" : OD 2"	2			
	800-58-20	Arbor, Clutch Release - R100	1			
	800-70-86	Snap Ring, External - 1 1/2"	1			
<b>33</b>	<b>800-75-21</b>	<b>CLUTCH RELEASE ASSEMBLY - R1000/R5500S</b>		<b>1</b>	<b>1</b>	<b>1</b>
	800-06-12	Sprocket, Dual Clutch Release - 41B25/27 - R1000/R5500s		1	1	1
	800-22-06	Spring - 1 1/4" x 1" (3 1/4 turns)		1	1	1
	800-24-01	4-Pin Disc - R1000/R5500s		1	1	1
	800-40-56	Washer, Flat - ID 1 1/16" : OD 2" : Thickness .090"		1	1	1
	800-58-21	Arbor, Clutch Release - 1"		1	1	1
	800-70-86	Snap Ring, External - 1 1/2"		1	1	1
<b>34</b>	<b>800-75-30</b>	<b>IDLER WHEEL ASSEMBLY - R100</b>	<b>1</b>			
	800-36-52	Bolt, Hex Head - 5/8" - 11 x 3 1/2"	1			
	800-38-18	Nut, Hex Head - 5/8"	1			
	800-73-70	Idler Wheel, UHMW - 2 1/2" x 1 1/4" - I.D. 5/8"	1			

## BILL OF MATERIALS

ITEM	PART #	PART DESCRIPTION	RAM 100	RAM 1000	RAM 5500-3/4	RAM 5500-1
35	<b>800-75-31</b>	<b>IDLER WHEEL ASSEMBLY - R1000/R5500S</b>		<b>2</b>	<b>2</b>	<b>2</b>
	800-36-52	Bolt, Hex Head - 5/8" - 11 x 3 1/2"		1	1	1
	800-38-18	Nut, Hex Head - 5/8"		2	2	2
	800-40-45	Washer, Flat - ID 3/4" : OD 1 1/4"		2	2	2
	800-46-01	Bushing, Idler Wheel Sleeve - ID 5/8" : OD 7/8" x 1 13/16"		1	1	1
	800-73-71	Idler Wheel, UHMW - 3 1/2" x 1 1/2" - I.D. 7/8"		1	1	1
36	<b>800-75-72</b>	<b>LIMIT SHAFT ASSEMBLY - R100</b>	<b>1</b>			
	800-12-04	Shaft, Limit Switch - 1/2" - 11 x 10 1/4" (6 3/8" of thread, 5/8" thread shaft) [R100]	1			
	800-20-50	Limit Switch Nuts - R100	2			
	800-44-04	Bearing, Sealed - 6202RS x 1/2"	2			
	800-70-10	Collar, Limit Shaft - 1/2"	2			
37	<b>800-75-73</b>	<b>Limit Shaft Assembly - R1000/R5500s</b>		<b>1</b>	<b>1</b>	<b>1</b>
	800-12-03	Shaft, Limit Switch - 3/4" - 14 x 10 3/4" (6 1/2" of thread, 1" thread shaft)		1	1	1
	800-20-51	Limit Switch Nuts - R1000/R5500s		2	2	2
	800-44-03	Bearing, Sealed - 3/4"		2	2	2
	800-70-11	Collar, Limit Shaft - 3/4"		2	2	2
38	<b>800-75-07</b>	<b>COVER ASSEMBLY - R100</b>	<b>1</b>			
	800-14-00	Cover, Polyethylene - R100	1			
	800-70-46	Logo, Plastic	1			
	800-38-90	Nut, Hex Head K-Lock - #6	6			
	800-32-40	Screw, Machine - #6 - 32 x 1/2" (flat)	2			
	800-70-53	Plate, UL Sticker	1			
39	<b>800-75-08</b>	<b>COVER ASSEMBLY - R1000/R5500S</b>		<b>1</b>	<b>1</b>	<b>1</b>
	800-14-01	Cover, Polyethylene - R1000/R5500s		1	1	1
	800-70-46	Logo, Plastic		1	1	1
	800-38-90	Nut, Hex Head K-Lock - #6		6	6	6
	800-32-40	Screw, Machine - #6 - 32 x 1/2" (flat)		2	2	2
	800-70-53	Plate, UL Sticker		1	1	1
40	<b>800-75-65</b>	<b>CHAIN KIT - R100</b>	<b>1</b>			
	800-38-16	Nut, Hex Head - 1/2"	4			
	800-52-02	Chain - #41 (10ft per box)	2			
	800-52-30	Chain Bolt - 1/2" - 13 x 3 1/4"	2			
	800-52-51	Master Link - #41	1			
	800-54-15	Bracket, Chain (Left) - 3/8" x 2" x 2" x 3 1/4"	1			
	800-54-16	Bracket, Chain (Right) - 3/8" x 2" x 2" x 3 1/4"	1			
41	<b>800-75-66</b>	<b>CHAIN KIT - R1000/R5500S</b>		<b>1</b>	<b>1</b>	<b>1</b>
	800-38-16	Nut, Hex Head - 1/2"		4	4	4
	800-52-00	Chain - #40 (10ft per box)		2	2	2
	800-52-30	Chain Bolt - 1/2" - 13 x 3 1/4"		2	2	2
	800-52-50	Master Link - #40		1	1	1
	800-54-15	Bracket, Chain (Left) - 3/8" x 2" x 2" x 3 1/4"		1	1	1
	800-54-16	Bracket, Chain (Right) - 3/8" x 2" x 2" x 3 1/4"		1	1	1

# GATE ENTRANCE SAFETY PRECAUTIONS

RAM 100 • 1000 • 5500



## IMPORTANT SAFETY INSTRUCTIONS

**WARNING** To reduce the risk of severe injury or death:

1. READ AND FOLLOW ALL INSTRUCTIONS
2. Never let children operate or play with gate controls. Keep the remote control away from children.
3. Always keep people and objects away from the gate. **NO ONE SHOULD CROSS THE PATH OF THE MOVING GATE.**
4. Test the gate operator monthly. The gate **MUST** reverse on contact with a rigid object or stop when an object activates the non-contact sensors. After adjusting the force or the limit of travel, retest the gate operator. Failure to adjust and retest the gate operator properly can increase the risk of injury or death.
5. Use the emergency release only when the gate is not moving.
6. **KEEP GATES PROPERLY MAINTAINED.** Read the user's manual. Have a qualified service person make repairs to gate hardware.
7. The entrance is for vehicles only. Pedestrians must use separate entrance.
8. **SAVE THESE INSTRUCTIONS.**





## IMPORTANT INFORMATION FOR THE HOMEOWNER



RAM 100 • 1000 • 5500

- Ask your technician about all the features of your new Ramset gate operator.
- This operator should not be installed without at least one photo eye present.
- Other safety devices, such as reverse loops, phantom loops, additional photo eyes, or miller edges may need to be installed on your gate before the operator may be used. Ask your technician which safety devices best suit your safety needs.
- Read your warranty certificate and fill out your warranty extension card. Return the warranty card, via certified mail, to Ramset within 90 days of purchase:
 

**Ramset Automatic Gate Systems, Inc.**  
**9116 De Garmo Ave.**  
**Sun Valley, CA 91352**
- All warranty issues/claims must be redeemed by a technician.
- Homeowners should NEVER take the cover off the gate operator.
- Homeowners should NEVER try to work on, repair or service the gate operator.
- Never let children operate or play with gate controls. Keep the controls away from children.
- Never let children play in the area around the gate.
- Never let anyone ride, climb under or climb over the gate.
- Always keep people, children and objects away from the gate while the gate is in operation. No one should cross the area of a moving gate.
- The entrance is for vehicles only. Pedestrians should use a separate entrance.
- Use the emergency release only when the gate is not moving. Make sure before using the foot pedal release, the circuit breaker for the operator is turned off.
- Have the technician give you a demonstration of how to use the emergency release.
- Make sure that in your breaker box, the breaker for the operator is clearly marked and that you are aware of how to disable and enable the breaker.
- Keep gates properly maintained. Have a qualified gate technician service the gate operator and gate hardware every six months to a year. This includes checking of safety devices, E.R.D. and battery backup systems...etc.
- Frequently test and check all safety devices.
- Periodically test and check the battery backup and emergency release systems.
- Keep the gate operator area free of debris.
- Keep the area clean and pest free (insects and rodents can cause serious damage to the operator which is not covered under warranty).
- Warning signs must be placed on both sides of every gate in a highly visible area.
- To reset the audible alarm on the gate operator you must turn the circuit breaker for the operator off for approximately 10 seconds, and then back on. An exterior switch or button can also be installed on the operator to shut off the audible alarm.
- Always keep a good relationship with your technician and keep his or her number handy for future maintenance or emergencies.

<b>TROUBLESHOOTING TABLE</b>		
<b>CONDITION</b>	<b>POSSIBLE CAUSES</b>	<b>SOLUTION</b>
<b>NO LIGHTS ARE 'ON'.</b>	<ol style="list-style-type: none"> <li>1. Circuit breaker popped.</li> <li>2. 1/2 amp. fuse blown.</li> <li>3. Power supply damaged on Control Board.</li> </ol>	<ol style="list-style-type: none"> <li>1. Reset circuit breaker.</li> <li>2. Replace 1/2 amp. fuse.</li> <li>3. Return Control Board for repair.</li> </ol>
<b>GATE MOVES A COUPLE OF FEET AND THEN REVERSES.</b>	<ol style="list-style-type: none"> <li>1. E.R.D. too sensitive.</li> </ol>	<ol style="list-style-type: none"> <li>1. A) for 1/2 hp motors: turn dip switch "A" 4 'On'. B) for 3/4 hp motors: turn dip switch "B" 8 'On'.</li> </ol>
<b>"EXIT" L.E.D. IS ALWAYS 'ON'.</b>	<ol style="list-style-type: none"> <li>1. Faulty accessory connected to the "Exit".</li> </ol>	<ol style="list-style-type: none"> <li>1. Disconnect all accessories, including plug-ins, using the "Exit" input. If problem persist, contact Ramset.</li> </ol>
<b>"REV LOOP" L.E.D. ALWAYS 'ON'.</b>	<ol style="list-style-type: none"> <li>1. Faulty accessory connected to the "Rev Loop".</li> </ol>	<ol style="list-style-type: none"> <li>1. Disconnect all accessories, including plug-ins, using the "Rev Loop" input. If problem persist, contact Ramset.</li> </ol>
<b>"RADIO" L.E.D. ALWAYS 'ON'.</b>	<ol style="list-style-type: none"> <li>1. Stuck button on Transmitter</li> <li>2. Faulty Receiver.</li> </ol>	<ol style="list-style-type: none"> <li>1. Check all transmitters.</li> <li>2. Remove receiver. If problem persist, contact Ramset.</li> </ol>
<b>GATE DOESN'T OPEN.</b>	<ol style="list-style-type: none"> <li>1. Radio L.E.D. 'On'.</li> <li>2. 10 amp. fuse blown.</li> <li>3. Opening accessory not functioning.</li> </ol>	<ol style="list-style-type: none"> <li>1. See above symptoms/solutions.</li> <li>2. Check/replace 10 amp. fuse.</li> <li>3. Check/replace opening accessory.</li> </ol>
<b>GATE DOESN'T CLOSE.</b>	<ol style="list-style-type: none"> <li>1. No lights are 'On'.</li> <li>2. Exit, Rev Loop, Radio L.E.D. 'On'.</li> <li>3. 10 amp. fuse blown.</li> <li>4. Thermal/overload button popped on motor.</li> </ol>	<ol style="list-style-type: none"> <li>1. See above symptoms/solutions.</li> <li>2. See above symptoms/solutions.</li> <li>3. Check/replace 10 amp. fuse.</li> <li>4. Reset thermal/overload button on the back of the motor.</li> </ol>
<b>GATE DOESN'T CLOSE AUTOMATICALLY.</b>	<ol style="list-style-type: none"> <li>1. Dip switches "A" 1-3 are all 'Off'.</li> <li>2. Dip switch not on all the way.</li> </ol>	<ol style="list-style-type: none"> <li>1. Set dip switches "A" 1-3 for auto close.</li> <li>2. Turn off dip switches "A" 1-3, then turn the appropriate switches back 'On'.</li> </ol>
<b>GATE AUTOMATICALLY OPENS, BUT DOESN'T AUTOMATICALLY CLOSE.</b>	<ol style="list-style-type: none"> <li>1. Motor direction wrong.</li> </ol>	<ol style="list-style-type: none"> <li>1. Turn on dip switch "C" 7 (left/right).</li> </ol>
<b>RADIO/RECEIVER HAS NO RANGE.</b>	<ol style="list-style-type: none"> <li>1. Signal blocked.</li> <li>2. Area not suitable for type of Receiver.</li> </ol>	<ol style="list-style-type: none"> <li>1. Make sure antenna is in proper position &amp; not shorted to chassis.</li> <li>2. May need to change to long range receiver.</li> </ol>



9116 De Garmo Ave.  
Sun Valley, CA 91352  
Tel: (818) 504-2533 • Fax: (818) 504-1141  
[www.ramsetinc.com](http://www.ramsetinc.com)